

TM138 SERIES

(5.4" diameter)

DIMENSIONS (in inches)

TM138A25 Drum Motor (matching Idler KT138A25**)

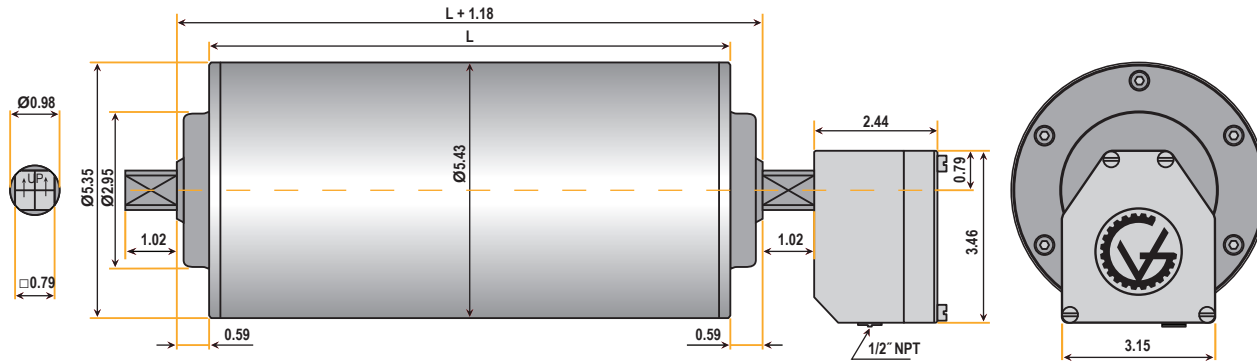

Standard face widths* (L) in inches:

9.84	10.83	11.81	13.78	15.75	17.72	19.69	21.65	23.62
25.59	27.56	29.53	31.50	33.46	35.43	37.40	39.37	41.34
43.31	45.28	47.24						

Bracket AB 25

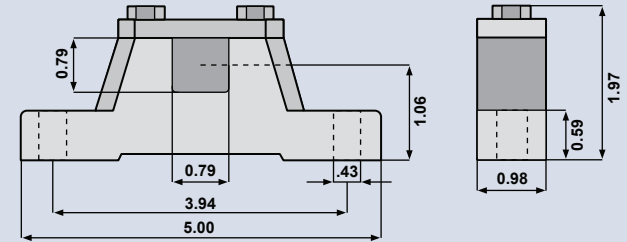

TM123B25 Drum Motor (matching Idler KT138B25**)

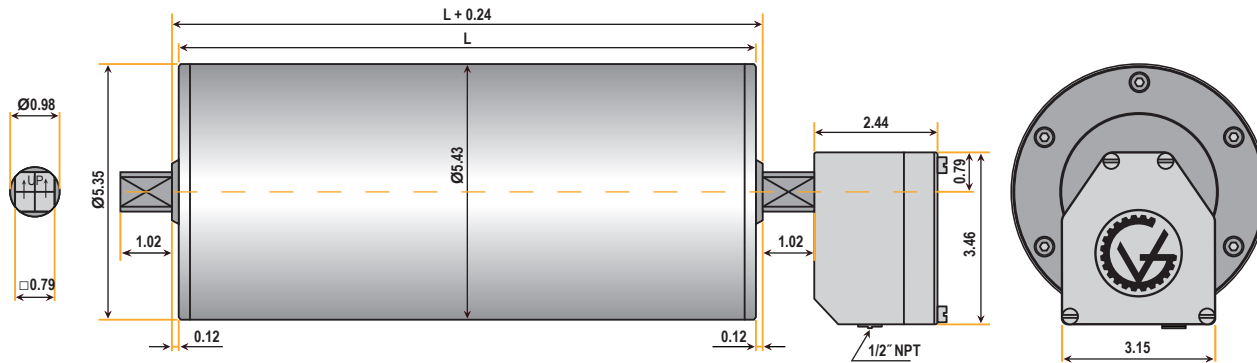

Standard face widths* (L) in inches:

10.83	11.81	13.78	15.75	17.72	19.69	21.65	23.62	25.59
27.56	29.53	31.50	33.46	35.43	37.40	39.37	41.34	43.31
45.28	47.24							

Optional Cable Type

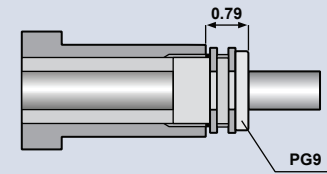

Note: When Optional Cable Type is selected, the minimum face width (L) increases by 1.969 inches.

*Some face widths are not available in all horsepower. For minimum available face widths refer to TM138 Specifications.

**Idler dimensions are identical to the drum motor with no junction box.