



1.1 Designazione

1.1 Designation

1.1 Bezeichnung

**EXR 501 708 P D**

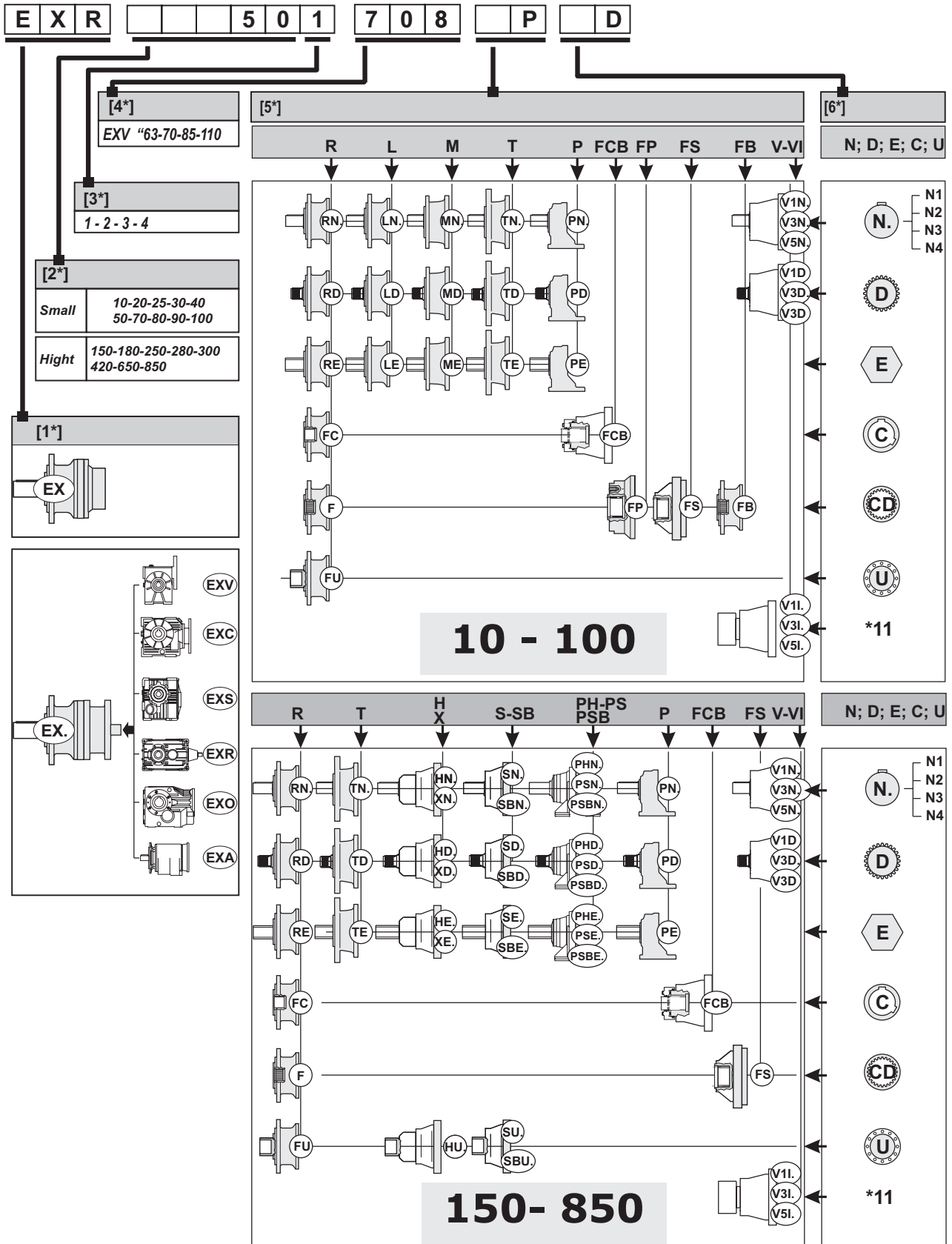

**EXR 501 708 PD 63.4 PAM100B5 A M11 ID**

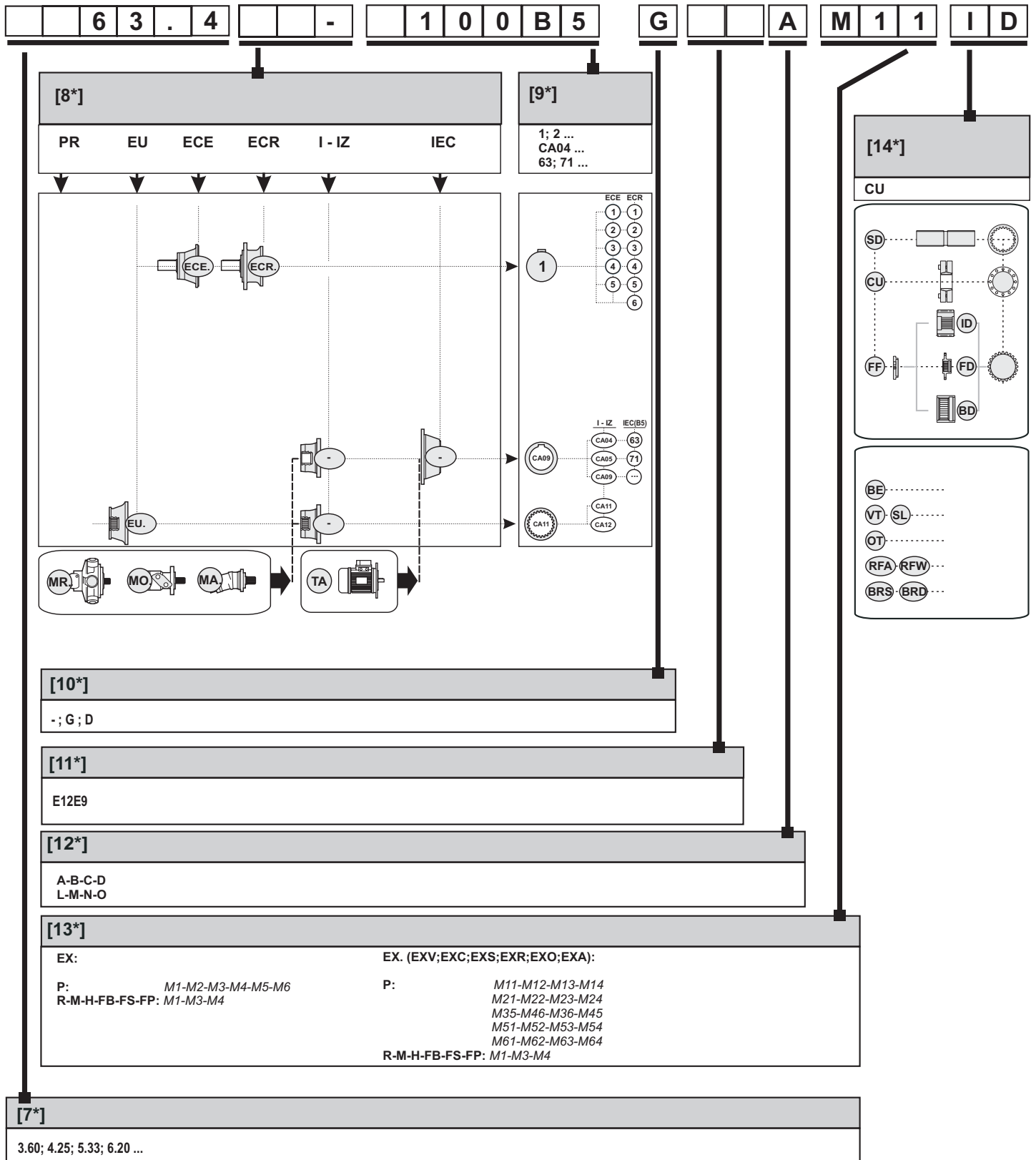

**B**

1.1 Designazione

1.1 Designation

1.1 Bezeichnung

[\*1] Forma Costruttiva

[\*1] Type of reduction unit

[\*1] Bauform getriebestufen

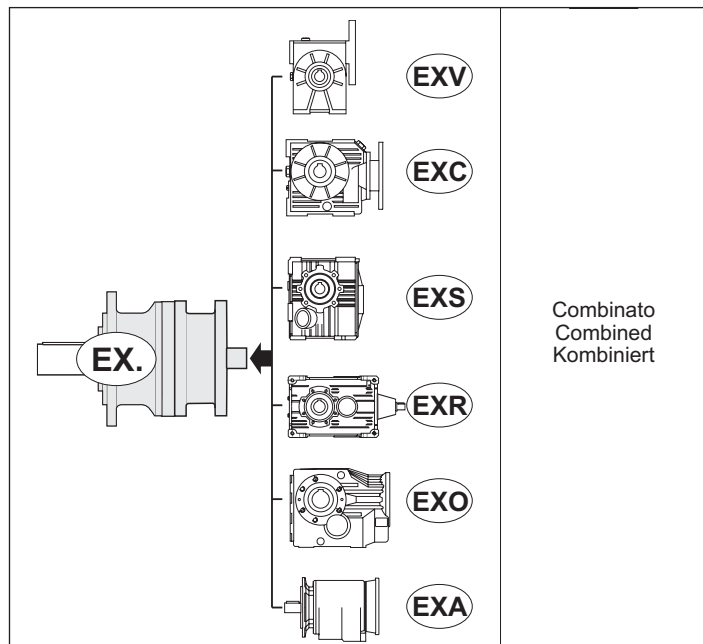
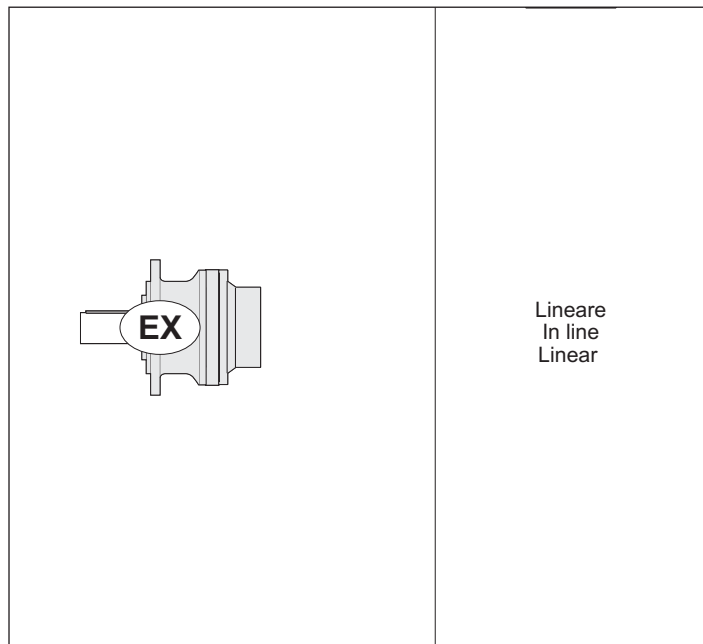

[\*2] Grandezza

[\*2] Size

[\*2] Grosse

10	20	25	30	40	50	70	80	90	100	150	180	250	280	300	420	650	850
----	----	----	----	----	----	----	----	----	-----	-----	-----	-----	-----	-----	-----	-----	-----

[\*3] N° Stadi

[\*3] N° of reductions

[\*3] N° Anzahl der stufen

[*3]	1-2-3-4				2-3-4	1-2-3-4		2-3-4	1-2-3-4		2-3-4	1-2-3-4		2-3-4	1-2-3-4		
[*2]	10	20	25	30	40	50	70	90	100	150	180	250	280	300	420	650	850

1.1 Designazione

1.1 Designation

1.1 Bezeichnung

[\*4] Riduttore Accoppiato

[\*4] Combined gearbox

[\*4] Kombiniertes Getriebe

	<b>1</b>				<b>2</b>				<b>3</b>				<b>4</b>			
10	101				102				103				104			
20	201				202				203				204			
25	251				252				253				254			
30		301			302				303				304			
40					402				403				404			
50		501			502				503				504			
70		701			702				703				704			
80			801		802				803				804			
90					902				903				904			
100			1001		1002				1003				1004			
150				1501	1502				1503				1504			
180					1802				1803				1804			
250					2501		2502		2503				2504			
280							2802		2803				2804			
300							3002		3003				3004			
420								4202	4203				4204			
650									6502		6503		6504			
850											8503		8504			

**B**

EXV 50	-				-				-				-			
EXV 63	-				-				-				-			
EXV 70	-				-				-				-			
EXV 85	-	-			-	-			-	-			-	-		
EXV 110		-	-		-	-			-	-	-		-	-		
EXV 130		-	-		-	-			-	-			-	-		
EXV 150			-	-		-	-			-	-			-	-	
EXV 180				-			-				-			-		
EXC 50	-				-				-				-			
EXC 70	-				-				-				-			
EXC 85	-	-			-	-			-	-			-	-		
EXC 110		-	-		-	-			-	-			-	-		
EXS 35	-				-				-				-			
EXS 45	-				-				-				-			
EXR 704	-				-				-				-			
EXR 708	-	-			-	-			-	-			-	-		
EXR 712		-	-		-	-			-	-			-	-		
EXR 716			-	-		-	-			-	-			-	-	
EXO 132				-	-			-	-				-			
EXO 150				-	-			-	-				-			
EXO 170				-	-			-	-				-			
EXO 190																
EXA 35	-				-				-				-			
EXA 41	-				-				-				-			
EXA 45	-				-				-				-			
EXA 50	-				-				-				-			

1.1 Designazione

1.1 Designation

1.1 Bezeichnung

[\*5] Tipo Supporto Uscita  
[\*6] Forma Uscita

[\*5] Output support  
[\*6] Output shaft

[\*5] Abtriebsselement  
[\*6] Abtriebsform



	10	20	25	30	40	50	70	80	90	100	150	180	250	280	300	420	650	850
<b>RN1</b>	ø38-58				ø60-105			ø80-130	ø90-170	ø90-170								
<b>RN2</b>	ø42-82				ø65-105				ø100-170	ø100-170								
<b>RN3</b>	ø50-82				ø50-100													
<b>RN4</b>	ø48-82																	
<b>RD</b>	B 40x36				B 58x53			B 70x64	B 80x74	B 80x74								
<b>LN1</b>	ø38-58				ø60-105													
<b>LN2</b>	ø42-82				ø65-105													
<b>LN3</b>	ø50-82				ø50-100													
<b>LN4</b>	ø48-82																	
<b>LD</b>	B 40x36				B 58x53													
<b>MN1</b>	ø60-105				ø60-105			ø80-130										
<b>MN2</b>	ø65-105				ø65-105													
<b>MN3</b>	ø50-100																	
<b>MD</b>	B 58x53				B 58x53			B 70x64										
<b>MXN1</b>					ø60-105													
<b>MXN2</b>					ø65-105													
<b>MD</b>					B 58x53													
<b>TN1</b>	ø38-58				ø60-105			ø80-130	ø90-170	ø90-170	ø 110-210	ø 120-210						
<b>TN2</b>	ø42-82				ø65-105				ø100-170	ø100-170								
<b>TN3</b>	ø50-82				ø50-100													
<b>TN4</b>	ø48-82																	
<b>TD</b>	B 40x36				B 58x53			B 70x64	B 80x74	B 80x74	B 100x94	W 120x3						
<b>HN1</b>									ø90-170	ø 110-210	ø 120-210							
<b>HN2</b>									ø100-210									
<b>HD</b>									B 80x74	B 100x94	W 120x3							
<b>XN1</b>																		
<b>XN2</b>									ø100-210									
<b>XD</b>									B 100x94									
<b>SN1</b>															ø 120-210	ø 160-240	ø 170-240	
<b>SN2</b>															ø 140-220			
<b>SD</b>															W 120x3	W150x5	W170x5	
<b>SBN1</b>															ø 120-210			
<b>SBN2</b>															ø 140-220			
<b>SBD</b>															W 120x3			



	10	20	25	30	40	50	70	80	90	100	150	180	250	280	300	420	650	850
<b>PN1</b>	ø38-58				ø60-105			ø80-130	ø90-170	ø 90-170								
<b>PN2</b>	ø42-82				ø65-105					ø100-210								
<b>PN3</b>	ø50-82																	
<b>PN4</b>	ø48-82																	
<b>PD</b>	B 40x36				B 58x53			B 70x64	B 80x74	B 80x74								
<b>PHN1</b>									ø90-170	ø 110-210	ø 120-210							
<b>PHN2</b>									ø100-210									
<b>PHD</b>									B 80x74	B 100x94	W 120x3							
<b>PXN1</b>																		
<b>PXN2</b>									ø100-210									
<b>PXD</b>									B 100x94									
<b>PSN1</b>															ø 120-210	ø 160-240	ø 170-240	
<b>PSN2</b>															ø 140-220			
<b>PSD</b>															W 120x3	W150x5	W170x5	
<b>PSBN1</b>															ø 120-210			
<b>PSBN2</b>															ø 140-220			
<b>PSBD</b>															W 120x3			

1.1 Designazione

1.1 Designation

1.1 Bezeichnung

[\*5] Tipo Supporto Uscita  
[\*6] Forma Uscita

[\*5] Output support  
[\*6] Output shaft

[\*5] Abtriebsselement  
[\*6] Abtriebsform

	10	20	25	30	40	50	70	80	90	100	150	180	250	280	300	420	650	850				
<b>F</b>	A 40x36		A 58x53				A 70x64		A 80x74													
<b>FB</b>							A 70x64		A 70x64													
<b>FP</b>			A 58x53																			
<b>FS</b>	A 40x36		A 58x53				A 70x64		A 80x74		A 80x74		A 100x94		N 120x5		N 120x3		N 150x5		N 170x5	
<b>FSB</b>															N 140x5							

**B**

	10	20	25	30	40	50	70	80	90	100	150	180	250	280	300	420	650	850	
<b>FC</b>	ø 35		ø 50				ø 65		ø 75										
<b>FCB</b>			ø 65				ø 80		ø 90		ø 100		ø 110						

	10	20	25	30	40	50	70	80	90	100	150	180	250	280	300	420	650	850		
<b>FU</b>	ø 50		ø 75				ø 90		ø 100		ø 120									
<b>HU</b>											ø 120		ø 130		ø 135					
<b>HU</b>															ø 145		ø 165		ø 180	
<b>TU</b>											ø 120				ø 135					

	10	20	25	30	40	50	70	80	90	100	150	180	250	280	300	420	650	850
<b>V1I</b>			E11E															
<b>V1I</b>			E12E															
<b>V1D</b>							B 80x64											
<b>V2I</b>			D14E															
<b>V3I</b>			D14D8				E12F				F13G							
<b>V3I</b>							E13E											
<b>V5I</b>							E13G5											

[\*7] Rapporto di riduzione ir

[\*7] Reduction ratio ir

7 [\*] Übersetzungsverhältnis ir

(Vedi prestazioni). Tutti i valori dei rapporti sono approssimati. Per applicazioni dove necessita il valore esatto consultare il ns. servizio tecnico.

(See ratings). Ratios are approximate values. If you need exact values for a specific application, please contact our Engineering.

(Siehe "Leistungen"). Bei allen Werten der Übersetzungen handelt es sich um approximative Wertangaben. Bei Applikationen, bei denen die exakte Wertangabe erforderlich ist, muss unser Technischer Kundendienst konsultiert werden.

**1.1 Designazione**

**1.1 Designation**

**1.1 Bezeichnung**

[\*8] Tipo Supporto Entrata

[\*8] Input support

[\*8] Antriebsselement

[\*9] Forma Entrata

[\*9] Input adjustment

[\*9] Antriebsform

Descrizione Predisposizione Adjustment description Beschreibung Vorbereitung	[*8]	[*9]	Note Remarks Merkmale
Senza Flangia Motore Beschreibung Vorbereitung Ohne Motorenflansch	<b>PR</b>		EX (fornito solare allegato) EX. Combinati (fornito solare di combinazione e paraolio allegati.). EX (solar pinion supply enclose) EX. Combined Gearbox (solar pinion and oilseal supply enclose) EX (Sonnenzahnrad wird mitgeliefert) EX Kombiniert (Sonnenzahnrad und Dichtung wird mitgeliefert)
Universale Universal	<b>EU</b>	-	Per Dimensioni e Predisposizioni disponibili vedere Sezione D See section D for adjustments and dimensions available Fuer Abmessungen und moegliche Vorbereitungen siehe Sektion D
Albero maschio cilindrico con linguetta Support with keyed cylindrical shaft Vollwelle mit Passfeder	<b>ECE</b>		

		<b>1</b>				<b>2</b>				<b>3</b>				<b>4</b>			
<b>10</b>		101				102				103				104			
<b>20</b>		201				202				203				204			
<b>25</b>		251				252				253				254			
<b>30</b>		301				302				303				304			
<b>40</b>						402				403				404			
<b>50</b>		501				502				503				504			
<b>70</b>		701				702				703				704			
<b>80</b>			801			802				803				804			
<b>90</b>						902				903				904			
<b>100</b>			1001	1001		1002				1003				1004			
<b>150</b>			1501		1502				1503				1504				
<b>180</b>					1802				1803				1804				
<b>250</b>				2501		2502				2503				2504			
<b>280</b>						2802	2802			2803				2804			
<b>300</b>						3002	3002			3003				3004			
<b>420</b>								4202		4203				4204			
<b>650</b>									6502		6503				6504		
<b>850</b>											8503	8503			8504		
		<b>D</b>	<b>L</b>	<b>R</b>	<b>G</b>												
<b>EU</b>		50x45		150	95												
<b>ECE 1</b>		24	50														
<b>ECE 2</b>	38	58															
<b>ECE 3</b>	42	82															
<b>ECE 4</b>	48	82															
<b>ECE 5</b>	28	50															



**1.1 Designazione**

**1.1 Designation**

**1.1 Bezeichnung**

[\*8] Tipo Supporto Entrata

[\*8] Input support

[\*8] Antriebsselement

[\*9] Forma Entrata

[\*9] Input adjustment

[\*9] Antriebsform

Descrizione Predisposizione Adjustment description Beschreibung Vorbereitung	[*8]	[*9]	Note Remarks Merkmale
Albero maschio cilindrico con linguetta - Rinforzata Reinforced support with keyed cylindrical shaft Vollwelle mit verstaerkter Passfeder	<b>ECR</b>		Per Dimensioni e Predisposizioni disponibili vedere Sezione D See section D for adjustments and dimensions available Fuer Abmessungen und moegliche Vorbereitungen siehe Sektion D

**B**

		<b>1</b>				<b>2</b>				<b>3</b>				<b>4</b>			
<b>10</b>		101				102				103				104			
<b>20</b>		201				202				203				204			
<b>25</b>		251				252				253				254			
<b>30</b>		301				302				303				304			
<b>40</b>						402				403				404			
<b>50</b>		501				502				503				504			
<b>70</b>		701				702				703				704			
<b>80</b>			801			802				803				804			
<b>90</b>						902				903				904			
<b>100</b>			1001	1001		1002				1003				1004			
<b>150</b>				1501	1502				1503				1504				
<b>180</b>					1802				1803				1804				
<b>250</b>				2501	2502				2503				2504				
<b>280</b>					2802	2802			2803				2804				
<b>300</b>					3002	3002			3003				3004				
<b>420</b>							4202		4203				4204				
<b>650</b>								6502	6503				6504				
<b>850</b>									8503	8503			8504				
		<b>D</b>	<b>L</b>	<b>R</b>	<b>G</b>												
<b>ECR0</b>		42	82	165	110												
<b>ECR1</b>		50	82	165	110												
<b>ECR2</b>	60	105	195	150													
<b>ECR3</b>	65	105	195	150													
<b>ECR4</b>	65	105	245	175													
<b>ECR5</b>	80	130	250	200													
<b>ECR6</b>	90	170	295	230													

**1.1 Designazione**

**1.1 Designation**

**1.1 Bezeichnung**

[\*8] Tipo Supporto Entrata

[\*8] Input support

[\*8] Antriebselement

[\*9] Forma Entrata

[\*9] Input adjustment

[\*9] Antriebsform

Descrizione Predisposizione Adjustment description Beschreibung Vorbereitung	[*8]	[*9]	Note Remarks Merkmale
Motore Elettrico Elektromotor Electric motor	<b>IEC</b>		Per Dimensioni e Predisposizioni disponibili vedere Sezione D See section D for adjustments and dimensions available Fuer Abmessungen und moegliche Vorbereitungen siehe Sektion D

		<b>1</b>				<b>2</b>				<b>3</b>				<b>4</b>			
<b>10</b>		101				102				103				104			
<b>20</b>		201				202				203				204			
<b>25</b>		251				252				253				254			
<b>30</b>		301				302				303				304			
<b>40</b>						402				403				404			
<b>50</b>		501				502				503				504			
<b>70</b>		701				702				703				704			
<b>80</b>			801			802				803				804			
<b>90</b>						902				903				904			
<b>100</b>			1001	1001		1002				1003				1004			
<b>150</b>				1501		1502				1503				1504			
<b>180</b>						1802				1803				1804			
<b>250</b>					2501	2502				2503				2504			
<b>280</b>						2802	2802			2803				2804			
<b>300</b>						3002	3002			3003				3004			
<b>420</b>								4202		4203				4204			
<b>650</b>									6502		6503				6504		
<b>850</b>											8503	8503			8504		

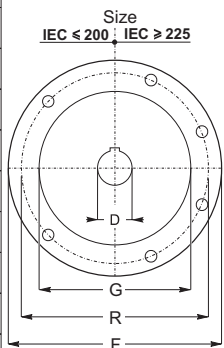

	D	F	R	G													
<b>63</b>	11	140	115	95													
<b>71</b>	14	160	130	110													
<b>80</b>	19	200	165	130													
<b>90</b>	24	200	165	130													
<b>100</b>	28	250	215	180													
<b>112</b>	28	250	215	180													
<b>132</b>	38	300	265	230													
<b>160</b>	42	350	300	250													
<b>180</b>	48	350	300	250													
<b>200</b>	55	400	350	300													
<b>225</b>	60	450	400	350													
<b>250</b>	65	550	500	450													

**1.1 Designazione**

**1.1 Designation**

**1.1 Bezeichnung**

[\*8] Tipo Supporto Entrata

[\*8] Input support

[\*8] Antriebsselement

[\*9] Forma Entrata

[\*9] Input adjustment

[\*9] Antriebsform

Descrizione Predisposizione Adjustment description Beschreibung Vorbereitung	[*8]	[*9]	Note Remarks Merkmale
Idrraulico - Motore Hydromotor Hydraulic motor	<b>I</b>		Per Dimensioni e Predisposizioni disponibili vedere Sezione D See section D for adjustments and dimensions available Fuer Abmessungen und moegliche Vorbereitungen siehe Sektion D

	<b>1</b>				<b>2</b>				<b>3</b>				<b>4</b>			
<b>10</b>	101				102				103				104			
<b>20</b>	201				202				203				204			
<b>25</b>	251				252				253				254			
<b>30</b>		301			302				303				304			
<b>40</b>					402				403				404			
<b>50</b>		501			502				503				504			
<b>70</b>		701			702				703				704			
<b>80</b>			801		802				803				804			
<b>90</b>					902				903				904			
<b>100</b>					1002				1003				1004			
<b>150</b>		1001	1001		1002				1003				1004			
<b>180</b>				1501	1502				1503				1504			
<b>250</b>					1802				1803				1804			
<b>280</b>				2501	2502				2503				2504			
<b>300</b>					2802	2802			2803				2804			
<b>420</b>					3002	3002			3003				3004			
<b>650</b>							4202		4203				4204			
<b>850</b>								6502		6503			6504			
									8503	8503			8504			

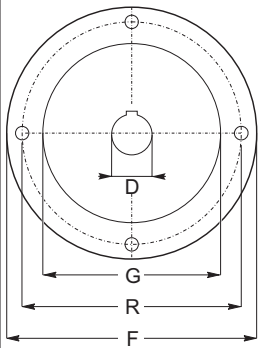

	D	R	G													
CA 04	25	106,4	82,6													
CA 05	25,4	106,4	82,6													
CA 06	31,75	106,4	82,6													
CA 09	1" 6B	106,4	82,6													
CA 11	12/24-12	106,4	82,6													
CA 12	12/24-14	106,4	82,6													
CA 15	16/32-13	106,4	82,6													
CB 07	32	106,4	82,6													
DB 04	25	125	100													
DA 11	12/24-12	125	100													
DB 21	N25x1,25	125	100													
DB 22	N30x2	125	100													
EA 15	16/32-13	146	101,6													
FA 13	12/24-16	160	125													
FA 22	N30x2	160	125													
FA 23	N35x2	160	125													
FA 24	N40x2	160	125													
FA 28	N32x2	160	125													
FB 08	40	160	125													
FB 14	12/24-17	160	125													
GA 17	16-32-21	162	127													
GB 17	16-32-21	181	127													
GC 08	40	162	127													
HA 10	10-20-16	180	140													
HB 23	N35x2	180	140													
HB 24	N40x2	180	140													
KB 22	N30x2	200	160													
KB 24	N40x2	200	160													
NA 29	28x34	160	125													
OA 31	36x40	250	150													
PA 29	28x34	210	175													

**1.1 Designazione**

**1.1 Designation**

**1.1 Bezeichnung**

[\*10] Tipo PAM

[\*10] IEC type

[\*10] IEC Typ

[*10]	Descrizione	EX Lineare / In line / Linear	EX. Combinato / Combined / Kombiniert					
			EXV	EXC	EXS	EXR	EXA	EXO
-	Con campana senza giunto Motor bell without coupling mit Glocke ohne Kupplung					RXP - RXO 704 - 708 712 - 716		-
G	Con giunto With coupling mit Kupplung		50 - 63		35 - 45	RXP - RXO 704 - 708 712 - 716	2C - 41 2C - 45	*
D	Accoppiamento diretto Direct coupling direkte Passung		50 - 63 70 - 85 110 - 130 150 - 180	50 - 70 85 - 110		RXO 704 - 708 712 - 716	35 3C - 41 3C - 45 50	*

- \* Contattare nostro ufficio tecnico commerciale
- \* Please, contact our technical sales dept.
- \* Bitte setzen Sie sich mit unserer technischen Abteilung in Verbindung

**[\*11] Pignoni dentati**

**[\*11] Output pinions**

**[\*11] Abtriebsritzel**

Modulo Normale Normal module Normales Modul	
Modulo Module Modul	Designazione Designation Bezeichnung
4.5	A
5	B
6	C
8	D
10	E
12	F
14	G
16	H
18	I
20	L

Numero Denti Number of Teeth Zahneanzahl	
N° Denti Teeth nr. Zahne Nr.	Designazione Designation Bezeichnung
10	10
11	11
12	12
13	13
14	14
15	15
16	16
17	17
18	18
19	19
20	20
21	21

Larghezza Fascia Teeth width Zahnbreite	
Larghezza Fascia Widht Zahnbreite	Designazione Designation Bezeichnung
40-49	A
50-59	B
60-69	C
70-79	D
80-89	E
90-99	F
100-109	G
110-119	H
120-129	I
130-139	L
140-149	M
150-159	N

1...9

Esempio:  
Se si vuole un pignone dentato per rotazione con modulo normale 10, numero denti 12, larghezza fascia 89 in designazione si dovrà riportare:  
**E12E9**

For example:  
If you require a rotation pinion with normal module 10, teeth number 12 and width 89 the description will be:  
**E12E9**

Z. B. Wenn Sie einen Ritzel fuer Drehung mit normalen Modul 10, Zahneanzahl 12 und Breite 89 benoetigen, wird die Beschreibung folgend sein:  
**E12E9**

**1.1 Designazione**

**1.1 Designation**

**1.1 Bezeichnung**

**[\*12] Versione di Montaggio**

APPLICABILITA': solo per prodotti combinati esempio EXV - EXC - EXS - EXR - EXO - EXA.

La versione di montaggio definisce la posizione reciproca del riduttore EX con il riduttore combinato.

Lo schema grafico è riportato nella Sezione V.

**[\*12] Mounting position**

Applicability: only for combined gearboxes type EXV - EXC - EXS - EXR - EXO and EXA.

The mounting position define the mountin position between the two gearboxes.

The graphic sketch is to the section V.

**[\*12] Montageversion**

Anwendung: nur für kombinierte Getriebe Typen EXV - EXC -EXS - EXR -.....

Die Montageversion zeigt die Position beider Getriebe.

Die Grafische Ausfuehrung finden Sie in der Sektion V.

Lato flangia uscita riduttore combinato <i>Combined gearbox output flange side</i> Montageseite Abtriebflansch für kombinierte Getriebe	Descrizione	<b>EX.</b>					
		Combinato / Combined / Kombiniert					
		EXV	EXC	EXS	EXR	EXO	EXA
		Designazione/Designation/Bezeichnung					
<b>DX</b>	flangia destra Right flange Flansch rechts	A - B - C - D					
<b>SX</b>	flangia sinistra Left flange Flansch links	L - M - N - O					



**[\*13] Posizioni di montaggio**

Dopo aver definito la versione di montaggio è necessario che sia indicata la posizione in cui il riduttore sarà montato.

Il primo numero indica la posizione di montaggio in cui si viene a trovare il riduttore EX mentre il secondo numero la posizione in cui si trova il riduttore combinato.

Attenersi a questi indicazioni per il riempimento dei rispettivi riduttori.

Lo schema grafico è riportato nella Sezione

**[\*13] Mounting positions**

After to have defined the mounting position it's necessary to show the position whose the gearbox will be mounted.

The first number is the EX mounting position while the second number is the combined gearbox position.

Follow this instructions for to fill the gearboxes.

On the section F there is the graphic sketch.

**[\*13] Einbautagen**

Nachdem die Einbaulage mitgeteilt wurde, muessen auch die Positionen der 2 Getriebe definiert werden.

Die erste Nummer ist die Einbaulage des EX Getriebe, die zweite das kombinierte Getriebe. Bitte das Oel dementsprechend fuellen.

Die Grafische Ausfuehrung finden Sie in der Sektion F.

<b>EX</b> (Lineare / In line / Linear)		
Tipo Supporto Uscita / Output support type / Abtriebselement	<b>P.</b>	<b>R - M - H - FB - FS - FP</b>
Designazione / Designation / Bezeichnung	M1 - M2 - M3 - M4 - M5 - M6	M1- M3 - M4

<b>EX.</b> (Combinato / Combined / Kombiniert)		
Tipo Supporto Uscita / Output support type / Abtriebselement	<b>P.</b>	<b>R - M - H - FB - FS - FP</b>
Designazione / Designation / Bezeichnung	M11 - M21 - M35 - M51 - M61 M12 - M22 - M46 - M52 - M62 M13 - M23 - M36 - M53 - M63 M14 - M24 - M45 - M54 - M64	M11 - M12 - M13 - M14 M35 - M46 - M36 - M45

**[\*14] Accessori**

**[\*14] Accessories**

**[\*14]**

<b>VT1</b>	Paraoli in viton in entrata	Viton oil seals at input end	Ölabdichtungen aus Viton im Antrieb
<b>VT2</b>	Paraoli in viton in uscita	Viton oil seals at output end	Ölabdichtungen aus Viton im Abtrieb
<b>VT</b>	Paraoli in viton in entrata ed in uscita	Viton oil seals at input and output end	Ölabdichtungen aus Viton im An- und Abtrieb
<b>OT</b>	Vaso Espansione	Expansion tank	Expansionsfaß

Vedi Sezione E.

To see section E.

Sie in der Sektion E.

## 1.2 Prestazioni

## 1.2 Performances

## 1.2 Leistungen

	ir	n <sub>2</sub> X h							n <sub>1</sub> =1400 rpm h=10000 h		T <sub>max</sub> [Nm]	T <sub>FU</sub> [Nm]
		T <sub>N</sub> [Nm]							T <sub>N</sub> [Nm]	P <sub>1</sub> [kW]		
		10000	20000	50000	100000	500000	1000000	2000000				
EX..1	3.48	1076	1025	957	906	807	655	532	432	18.6	1700	*
	4.26	1022	972	955	942	792	644	523	450	15.8	1550	
	5.77	939	889	802	723	551	521	493	479	12.4	1350	
	7.20	665	595	514	460	369	342	317	318	6.6	1050	
EX..2	12.11	1076	1025	957	906	807	655	532	628	7.9	1700	
	14.84	1022	972	955	942	792	644	523	655	6.7	1550	
	18.17	1022	972	955	942	792	644		696	5.8	1550	
	20.08	939	889	802	723	551	521		536	4.1	1700	
	24.60	1022	972	955	942	792	644		762	4.7	1550	
	30.69	1022	972	955	942	792	644		814	4.1	1550	
	33.28	939	889	802	723	551			558	2.6	1350	
	41.54	939	889	802	723	551			568	2.1	1350	
EX..3	51.84	665	595	514	460	369			395	1.2	1050	
	51.63	1022	972	955	942	792			861	2.6	1550	
	63.25	1022	972	955	942				877	2.2	1550	
	69.87	1076	1025	957	906				890	2.0	1700	
	77.48	1022	972	955	942				893	1.8	1550	
	85.59	1022	972	955	942				933	1.7	1550	
	104.85	1022	972	955	942				937	1.4	1550	
	106.82	1022	972	955	942				937	1.4	1550	
	130.86	1022	972	955	942				941	1.1	1550	
	141.90	1022	972	955	942				942	1.0	1550	
	144.55	1076	1025	957	906				909	1.0	1700	
	177.09	1022	972	955	942				946	0.83	1550	
	180.40	1076	1025	957	906				925	0.80	1700	
	221.00	1022	972	955	942				950	0.67	1550	
EX..4	239.64	939	889	802	723				784	0.51	1350	
	299.08	939	889	802	723				810	0.42	1350	
	220.10	1022	972	955	942				950	0.69	1550	
	243.14	1076	1025	957	906				947	0.62	1700	
	269.63	1022	972	955	942				954	0.56	1550	
	303.44	1076	1025	957					963	0.51	1700	
	364.89	1022	972	955					960	0.42	1550	
	403.08	1076	1025	957					984	0.39	1700	
	447.00	1022	972	955					963	0.34	1550	
	493.79	1022	972	955					965	0.31	1550	
	557.86	1022	972	955					967	0.28	1550	
	627.80	1076	1025						1017	0.26	1700	
	818.63	1022	972						975	0.19	1550	
	942.17	1022	972						939	0.16	1550	
1021.64	1022	972						956	0.15	1550		
1275.01	1022	972						1002	0.13	1550		
1591.22	1022	972						1049	0.10	1550		

\* Contattare nostro ufficio tecnico commerciale / \* Please, contact our technical sales dept. / \* Bitte setzen Sie sich mit unserer technischen Abteilung in Verbindung

P <sub>TN</sub>	P	R-L-F-FC-FU FB-FCB	M MX	FS FP
101	18.6	12.6	14.1	11.7
102	12.2	8.7	9.6	8.2
103	8.0	6.0	6.5	5.7
104	6.7	5.2	5.5	4.9

**1.2 Prestazioni**

**1.2 Performances**

**1.2 Leistungen**

	ir	n <sub>2</sub> X h							n <sub>1</sub> =1400 rpm h=10000 h		T <sub>max</sub> [Nm]	T <sub>FU</sub> [Nm]
		T <sub>N</sub> [Nm]							T <sub>N</sub> [Nm]	P <sub>1</sub> [kW]		
		10000	20000	50000	100000	500000	1000000	2000000				
EX..1	3.48	2100	1994	1854	1807	1374	1116	906	735	31.6	3400	*
	4.26	1951	1855	1822	1797	1349	1096	890	767	26.9	3000	
	5.77	1804	1673	1602	1444	1102	1042	864	816	21.1	2560	
	7.20	1329	1198	1044	941	739	693	669	670	13.9	2000	
EX..2	12.11	2100	1994	1854	1807	1374	1116	906	1068	13.5	3400	
	14.84	1951	1855	1822	1797	1349	1096	890	1115	11.5	3000	
	18.17	1951	1855	1822	1797	1349	1096		1185	10.0	3000	
	20.08	1804	1673	1602	1444	1102	1042		1073	8.2	2560	
	24.60	1951	1855	1822	1797	1349	1096		1297	8.1	3000	
	30.69	1951	1855	1685	1561	1308	1096		1321	6.6	3000	
	33.28	1804	1673	1602	1444	1102			1117	5.1	2560	
	41.54	1804	1673	1602	1444	1102			1137	4.2	2560	
51.84	1329	1198	1044	941	739			811	2.4	2000		
EX..3	51.63	1951	1855	1822	1797	1349			1621	4.9	3000	
	63.25	1951	1855	1822	1797				1722	4.2	3000	
	69.87	2100	1994	1854	1807				1741	3.9	3400	
	77.48	1951	1855	1822	1797				1775	3.6	3000	
	85.59	1951	1855	1822	1797				1779	3.2	3000	
	104.85	1951	1855	1822	1797				1786	2.7	3000	
	106.82	1951	1855	1822	1797				1787	2.6	3000	
	130.86	1951	1855	1822	1797				1794	2.1	3000	
	141.90	1951	1855	1822	1797				1797	2.0	3000	
	144.55	2100	1994	1854	1807				1753	1.9	3400	
	177.09	1951	1855	1822	1797				1805	1.6	3000	
	180.40	2100	1994	1854	1807				1787	1.5	3400	
	221.00	1951	1855	1822	1797				1813	1.3	3000	
	239.64	1804	1673	1602	1444				1565	1.0	2560	
299.08	1804	1673	1602	1444				1618	0.84	2560		
EX..4	220.10	1951	1855	1822	1797				1813	1.31	3000	
	243.14	2100	1994	1854	1807				1832	1.20	3400	
	269.63	1951	1855	1822	1797				1821	1.08	3000	
	303.44	2100	1994	1854	1807				1866	0.98	3400	
	364.89	1951	1855	1822	1797				1832	0.80	3400	
	403.08	2100	1994	1854	1807				1910	0.75	3000	
	447.00	1951	1855	1822	1797				1839	0.66	3000	
	493.79	1951	1855	1822	1797				1843	0.59	3000	
	557.86	1951	1855	1822	1797				1847	0.53	3400	
	627.80	2100	1994	1854	1807				1977	0.50	3000	
	818.63	1951	1855	1822	1797				1861	0.36	3000	
	942.17	1951	1855	1822	1797				1801	0.30	3000	
	1021.64	1951	1855	1822	1797				1831	0.29	3000	
	1275.01	1951	1855	1822	1797				1915	0.24	3000	
1591.22	1951	1855	1685	1561				1999	0.20	3000		

**B**

\* Contattare nostro ufficio tecnico commerciale / \* Please, contact our technical sales dept. / \* Bitte setzen Sie sich mit unserer technischen Abteilung in Verbindung

P <sub>TN</sub>	P	R-L-F-FC-FU FB-FCB	M MX	FS FP
<b>201</b>	19.3	13.3	14.8	12.4
<b>202</b>	12.6	9.2	10.0	8.6
<b>203</b>	8.2	6.2	6.7	5.9
<b>204</b>	6.8	5.3	5.7	5.1



## 1.2 Prestazioni

## 1.2 Performances

## 1.2 Leistungen

	ir	n <sub>2</sub> X h							n <sub>1</sub> =1400 rpm h=10000 h		T <sub>max</sub> [Nm]	T <sub>FU</sub> [Nm]
		T <sub>N</sub> [Nm]							T <sub>N</sub> [Nm]	P <sub>1</sub> [kW]		
		10000	20000	50000	100000	500000	1000000	2000000				
EX..1	4.26	2407	2292	2250	2219	1795	1458	1184	1020	35.8	4000	*
EX..2	14.84	2407	2292	2250	2219	1795	1458	1184	1483	15.3	4000	
	18.17	2407	2292	2250	2219	1795	1458		1576	13.2	4000	
	24.60	2407	2292	2250	2219	1795	1458		1726	10.7	4000	
	30.69	2195	1964	1685	1561	1308	1212		1321	6.6	4000	
EX..3	51.63	2407	2292	2250	2219	1795			2031	6.13	4000	
	63.25	2407	2292	2250	2219	1795			2065	5.09	4000	
	77.48	2407	2292	2250	2219				2101	4.23	4000	
	85.59	2407	2292	2250	2219				2196	4.00	4000	
	106.82	2407	2292	2250	2219				2206	3.22	4000	
	130.86	2407	2292	2250	2219				2216	2.64	4000	
	141.90	2407	2292	2250	2219				2219	2.44	4000	
	177.09	2407	2292	2250	2219				2229	1.96	4000	
221.00	2195	1964	1685	1561				1642	1.16	4000		
EX..4	220.10	2407	2292	2250	2219				2239	1.62	4000	
	269.63	2407	2292	2250	2219				2248	1.33	4000	
	297.86	2407	2292	2250	2219				2253	1.21	4000	
	330.31	2407	2292	2250					2258	1.09	4000	
	371.73	2407	2292	2250					2263	0.97	4000	
	447.00	2407	2292	2250					2271	0.81	4000	
	493.79	2407	2292	2250					2276	0.73	4000	
	557.86	2407	2292	2250					2281	0.65	4000	
	616.26	2407	2292						2286	0.59	4000	
	754.94	2407	2292						2295	0.48	4000	
	818.63	2407	2292						2299	0.45	4000	
	942.17	2407	2292						2223	0.38	4000	
	1021.64	2407	2292						2261	0.35	4000	
	1275.01	2407	2292						2364	0.30	4000	
1591.22	2195	1964						2240	0.22	4000		

\* Contattare nostro ufficio tecnico commerciale / \* Please, contact our technical sales dept. / \* Bitte setzen Sie sich mit unserer technischen Abteilung in Verbindung

P <sub>TN</sub>	P	R-L-F-FC-FU FB-FCB	M MX	FS FP
<b>251</b>	19.3	13.3	14.8	12.4
<b>252</b>	12.6	9.2	10.0	8.6
<b>253</b>	8.2	6.2	6.7	5.9
<b>254</b>	6.8	5.3	5.7	5.1



**1.2 Prestazioni**

**1.2 Performances**

**1.2 Leistungen**

	ir	n <sub>2</sub> X h							n <sub>1</sub> =1400 rpm h=10000 h		T <sub>max</sub> [Nm]	T <sub>FU</sub> [Nm]
		T <sub>N</sub> [Nm]							T <sub>N</sub> [Nm]	P <sub>1</sub> [kW]		
		10000	20000	50000	100000	500000	1000000	2000000				
EX..1	3.60	3103	2796	2748	2711	2317	1882	1528	1252	52.0	3900	
	4.25	2794	2601	2557	2523	2283	1855	1506	1297	45.6	3500	
	5.33	2657	2383	2339	2306	2215	1799	1461	1347	37.8	3600	
	6.20	2205	2037	2001	1973	1596	1522	1446	1394	33.6	3100	
	7.50	2029	1880	1741	1539	1200	1145	1091	1096	21.9	2550	
EX..2	12.53	3103	2796	2748	2711	1795	1458	1184	1410	17.2	3900	
	14.79	2794	2601	2557	2523	2017	1638	1330	1665	17.2	3500	
	15.35	3103	2796	2748	2711	1763	1432		1472	14.6	3900	
	18.12	2794	2601	2557	2523	1980	1608		1737	14.6	3500	
	20.77	2961	2669	2100	1986	1712	1391		1565	11.5	3900	
	22.74	2657	2383	2339	2306	2215	1585		2081	14.0	3600	
	24.52	2794	2601	2446	2314	1923	1562		1848	11.5	3500	
	26.43	2205	2037	2001	1973	1596	1522		1590	9.2	3100	
	30.77	2657	2383	2339	2306	2215			2233	11.1	3600	
	35.77	2205	2037	2001	1973	1596			1622	6.9	3100	
	38.40	2649	2371	2057	1906	1596			1653	6.6	3600	
	44.64	2205	2037	2001	1973	1596			1646	5.6	3100	
	54.00	2029	1880	1741	1539	1200			1252	3.5	2550	
EX..3	43.60	3103	2796	2748	2711	1795			2050	7.3	3900	
	51.47	2794	2601	2557	2523	2017			2421	7.3	3500	
	53.41	3103	2796	2748	2711	1795			2179	6.4	3900	
	63.05	2794	2601	2557	2523				2485	6.1	3500	
	72.28	3103	2796	2748	2711				2386	5.1	3900	
	77.24	2794	2601	2557	2523				2495	5.0	3500	
	85.33	2794	2601	2557	2523				2500	4.6	3500	
	104.53	2794	2601	2557	2523				2509	3.7	3500	
	106.49	2794	2601	2557	2523				2510	3.7	3500	
	130.45	2794	2601	2557	2523				2520	3.0	3500	*
	141.46	2794	2601	2446	2314				2316	2.6	3500	
	163.71	2657	2383	2339	2306				2314	2.2	3600	
	176.54	2794	2601	2446	2314				2357	2.1	3500	
	190.31	2205	2037	2001	1973				1985	1.6	3100	
	221.54	2657	2383	2339	2306				2328	1.6	3600	
	257.54	2205	2037	2001	1973				1997	1.2	3100	
	276.48	2649	2371	2057	1906				2054	1.16	3600	
	321.41	2205	2037	2001					2006	0.97	3100	
EX..4	219.42	2794	2601	2557					2600	1.89	3500	
	268.80	2794	2601	2557					2600	1.54	3500	
	296.94	2794	2601	2557					2600	1.40	3500	
	329.29	2794	2601	2557					2600	1.26	3500	
	363.76	2794	2601	2557					2600	1.14	3500	
	416.98	3103	2796	2748					2800	1.07	3900	
	453.98	2794	2601	2557					2600	0.91	3500	
	492.27	2794	2601	2557					2600	0.84	3500	
	556.14	2794	2601	2557					2600	0.74	3500	
	614.35	2794	2601						2600	0.67	3500	
	766.71	2794	2601						2600	0.54	3500	
	795.61	3103	2796						2800	0.56	3900	
	939.26	2794	2601						2700	0.46	3500	
	1018.49	2794	2601						2700	0.42	3500	
	1178.68	2649	2371						2600	0.35	3600	
	1271.08	2794	2601						2700	0.34	3500	
	1595.08	2649	2371						2700	0.27	3600	
	1990.66	2649	2371						2700	0.22	3600	

\* Contattare nostro ufficio tecnico commerciale / \* Please, contact our technical sales dept. / \* Bitte setzen Sie sich mit unserer technischen Abteilung in Verbindung

P <sub>TN</sub>	P	R-L-F-FC-FU FB-FCB	M MX	FS FP	T
<b>301</b>	30.0	196.6	23.2	14.4	28.6
<b>302</b>	20.4	14.5	16.5	11.5	19.6
<b>303</b>	12.8	9.3	10.5	7.6	12.3
<b>304</b>	10.3	7.7	8.6	6.4	9.9



## 1.2 Prestazioni

## 1.2 Performances

## 1.2 Leistungen

	ir	n <sub>2</sub> X h							n <sub>1</sub> =1400 rpm h=10000 h		T <sub>max</sub> [Nm]	T <sub>FU</sub> [Nm]
		T <sub>N</sub> [Nm]							T <sub>N</sub> [Nm]	P <sub>1</sub> [kW]		
		10000	20000	50000	100000	500000	1000000	2000000				
EX..2	12.53	5471	4715	3582	2910	1795	1458	1184	1410	17.2	7000	
	14.79	5378	4978	4023	3268	2017	1638	1330	1665	17.2	6700	
	15.35	5471	4629	3517	2856	1763	1432		1472	14.6	7000	
	18.12	5378	4978	3950	3208	1980	1608		1737	14.6	6700	
	20.77	5471	4497	3416	2775	1712	1391		1565	11.5	7000	
	22.74	5234	4556	4468	3761	2321	1885		2180	14.6	7000	
	24.52	5378	4978	3837	3116	1923	1562		1848	11.5	6700	
	26.43	4210	3877	3805	3750	2579	2095		2534	14.6	6000	
	30.77	5234	4556	4468	3653	2254			2319	11.5	7000	
	35.77	4210	3877	3805	3750	2505			2696	11.5	6000	
	38.40	5234	4556	4228	3604	2224			2445	9.7	7000	
44.64	4210	3877	3805	3750	2471			2842	9.7	6000		
54.00	3874	3585	3362	2974	2339			2439	6.9	5000		
EX..3	43.60	5471	4715	3582	2910	1795			2050	7.3	7000	
	51.47	5378	4978	4023	3268	2017			2421	7.3	6700	
	53.41	5471	4629	3517	2856	1763			2139	6.2	7000	
	63.05	5378	4978	4023	3268				2573	6.4	6700	
	72.28	5471	4715	3582	2910				2386	5.1	7000	
	77.24	5378	4978	3950	3208				2684	5.4	6700	
	85.33	5378	4978	4023	3268				2817	5.1	6700	
	104.53	5378	4978	3950	3208				2939	4.4	6700	
	106.49	5378	4978	4023	3268				3011	4.4	6700	
	130.45	5378	4978	3950	3208				3141	3.8	6700	
	141.46	5378	4978	3837	3116				3126	3.4	6700	
	163.71	5234	4556	4468	3761				3942	3.8	7000	*
	176.54	5378	4978	3837	3116				3341	3.0	6700	
	190.31	4210	3877	3805	3750				3774	3.1	6000	
	221.54	5234	4556	4468	3653				4193	3.0	7000	
	257.54	4210	3877	3805	3750				3798	2.3	6000	
276.48	5234	4556	4228	3604				4220	2.4	7000		
321.41	4210	3877	3805					3815	1.9	6000		
EX..4	219.42	5378	4978	4023					4000	2.9	6700	
	268.80	5378	4978	4023					4000	2.4	6700	
	296.94	5378	4978	4023					4000	2.1	6700	
	329.29	5378	4978	4023					4000	1.9	6700	
	363.76	5378	4978	4023					4000	1.8	6700	
	416.98	5471	4715	3582					4500	1.7	7000	
	453.98	5378	4978	4023					4900	1.7	6700	
	492.27	5378	4978	4023					4900	1.6	6700	
	556.14	5378	4978	4023					4900	1.40	6700	
	614.35	5378	4978						4900	1.27	6700	
	766.71	5378	4978						4900	1.02	6700	
	795.61	5471	4715						4700	0.94	7000	
	939.26	5378	4978						5000	0.85	6700	
	1018.49	5378	4978						5000	0.78	6700	
	1178.68	5234	4556						5200	0.70	7000	
	1271.08	5378	4978						5300	0.66	6700	
	1595.08	5234	4556						5300	0.53	7000	
1990.66	5234	4556						5300	0.42	7000		

\* Contattare nostro ufficio tecnico commerciale / \* Please, contact our technical sales dept. / \* Bitte setzen Sie sich mit unserer technischen Abteilung in Verbindung

P <sub>TN</sub>	P	R-L-F-FC-FU FB-FCB	M MX	FS FP	T
402	21.2	15.2	17.3	12.2	20.3
403	13.3	9.8	11.0	8.0	12.8
404	10.6	8.0	8.9	6.7	10.2

**1.2 Prestazioni**

**1.2 Performances**

**1.2 Leistungen**

	ir	n <sub>2</sub> X h							n <sub>1</sub> =1400 rpm h=10000 h		T <sub>max</sub> [Nm]	T <sub>FU</sub> [Nm]
		T <sub>N</sub> [Nm]							T <sub>N</sub> [Nm]	P <sub>1</sub> [kW]		
		10000	20000	50000	100000	500000	1000000	2000000				
EX..1	3.60	5471	5086	4995	4926	4067	3303	2683	2198	91.3	7000	
	4.25	5378	4978	4890	4823	4008	3256	2644	2277	80.1	6700	
	5.33	5234	4556	4468	4402	3889	3159	2566	2365	66.3	7000	
	6.20	4210	3877	3805	3750	3123	2974	2538	2448	59.1	6000	
	7.50	3874	3585	3362	2974	2339	2233	2127	2137	42.6	5000	
EX..2	12.53	5471	5086	4995	4926	3287	2670	2169	2583	31.5	7000	
	14.79	5378	4978	4890	4823	3692	2999	2436	3049	31.5	6700	
	15.35	5471	5086	4995	4926	3227	2621		2695	26.8	7000	
	18.12	5378	4978	4890	4823	3625	2944		3181	26.8	6700	
	20.77	5471	5086	4200	3973	3135	2546		2866	21.1	7000	
	22.74	5234	4556	4468	4402	3889	3159		3653	24.5	7000	
	24.52	5378	4978	4890	4629	3521	2860		3383	21.1	6700	
	26.43	4210	3877	3805	3750	3123	2974		3110	18.0	6000	
	30.77	5234	4556	4468	4402	3889			4000	19.9	7000	
	35.77	4210	3877	3805	3750	3123			3175	13.6	6000	
	38.40	5234	4556	4228	3721	3433			3488	13.9	7000	
	44.64	4210	3877	3805	3750	3123			3223	11.0	6000	
	54.00	3874	3585	3362	2974	2339			2439	6.9	5000	
EX..3	43.60	5471	5086	4995	4926	3287			3754	13.4	7000	
	51.47	5378	4978	4890	4823	3692			4432	13.4	6700	
	53.41	5471	5086	4995	4926	3227			3917	11.4	7000	
	63.05	5378	4978	4890	4823				4710	11.7	6700	
	72.28	5471	5086	4995	4926				4369	9.4	7000	
	77.24	5378	4978	4890	4823				4765	9.6	6700	
	85.33	5378	4978	4890	4823				4775	8.7	6700	
	104.53	5378	4978	4890	4823				4794	7.2	6700	
	106.49	5378	4978	4890	4610				4474	6.6	6700	
	130.45	5378	4978	4890	4823				4816	5.8	6700	*
	141.46	5378	4978	4890	4629				4633	5.1	6700	
	163.71	5234	4556	4468	4402				4416	4.2	7000	
	176.54	5378	4978	4890	4629				4716	4.2	6700	
	190.31	4210	3877	3805	3750				3774	3.1	6000	
	221.54	5234	4556	4468	4402				4445	3.1	7000	
	257.54	4210	3877	3805	3750				3798	2.3	6000	
	276.48	5234	4556	4228	3721				4220	2.4	7000	
321.41	4210	3877	3805					3815	1.9	6000		
EX..4	219.42	5378	4978	4890					4900	3.6	6700	
	268.80	5378	4978	4890					4900	2.9	6700	
	296.94	5378	4978	4890					4900	2.6	6700	
	329.29	5378	4978	4890					4900	2.4	6700	
	363.76	5378	4978	4890					4900	2.1	6700	
	416.98	5471	5086	4995					5000	1.9	7000	
	453.98	5378	4978	4890					5000	1.8	6700	
	492.27	5378	4978	4890					5000	1.6	6700	
	556.14	5378	4978	4890					5000	1.43	6700	
	614.35	5378	4978						5000	1.30	6700	
	766.71	5378	4978						5000	1.04	6700	
	795.61	5471	5086						5100	1.02	7000	
	939.26	5378	4978						5000	0.85	6700	
	1018.49	5378	4978						5000	0.78	6700	
	1178.68	5234	4556						5200	0.70	7000	
	1271.08	5378	4978						5300	0.66	6700	
	1595.08	5234	4556						5300	0.53	7000	
1990.66	5234	4556						5300	0.42	7000		

\* Contattare nostro ufficio tecnico commerciale / \* Please, contact our technical sales dept. / \* Bitte setzen Sie sich mit unserer technischen Abteilung in Verbindung

P <sub>TN</sub>	P	R-L-F-FC-FU FB-FCB	M MX	FS FP	T
<b>501</b>	31.4	21.0	24.6	15.8	29.9
<b>502</b>	21.6	15.7	17.7	12.7	20.8
<b>503</b>	13.5	10.0	11.2	8.3	13.0
<b>504</b>	10.8	8.2	9.1	6.9	10.4



## 1.2 Prestazioni

## 1.2 Performances

## 1.2 Leistungen

	ir	n <sub>2</sub> X h							n <sub>1</sub> =1400 rpm h=10000 h		T <sub>max</sub> [Nm]	T <sub>FU</sub> [Nm]
		T <sub>N</sub> [Nm]							T <sub>N</sub> [Nm]	P <sub>1</sub> [kW]		
		10000	20000	50000	100000	500000	1000000	2000000				
EX..1	3.60	6729	6261	6148	6062	5423	4405	3578	2931	121.8	9100	*
	5.33	5378	4978	4890	4823	4667	4211	3421	3153	88.4	9100	
EX..2	15.35	6729	6261	6148	6062	4303	3495	2839	3593	35.7	9100	
	22.71	5378	4978	4890	4823	4667	4405		4646	31.2	9100	
EX..3	53.41	6729	6261	6148	6062	4303			5223	15.3	9100	
	65.43	6729	6261	6148	6062	4303			5551	13.2	9100	
	79.07	6729	6261	6148	6062				5991	11.8	9100	
	88.54	6729	6261	6148	6062				6005	10.6	9100	
	96.87	5378	4978	4890	4823				4787	7.7	9100	
	110.50	6691	6261	6148	5920				5841	8.2	9100	
	131.09	5234	4556	4468	4402				4395	5.2	9100	
163.60	5471	5086	4995	4926				4941	4.7	9100		
EX..4	185.86	6729	6261	6148	6062				6000	5.1	9100	
	227.69	6729	6261	6148	6062				6000	4.2	9100	
	278.93	6729	6261	6148	6062				6000	3.4	9100	
	308.13	6729	6261	6148	6062				6200	3.2	9100	
	337.11	6729	6261	6148					6200	2.9	9100	
	384.54	6729	6261	6148					6200	2.6	9100	
	412.97	5378	4978	4890					4900	1.9	9100	
	471.08	6729	6261	6148					6200	2.1	9100	
	510.82	6729	6261	6148					6200	1.9	9100	
	558.87	5234	4556	4468					4500	1.3	9100	
	569.34	5471	5086	4995					5000	1.4	9100	
	637.51	6729	6261	6148					6200	1.5	9100	
	697.47	5378	4978	4890					5000	1.1	9100	
	795.61	6691	6261	6148					6300	1.3	9100	
943.86	5234	4556	4468					5200	0.9	9100		
1177.94	5471	5086	4995					5200	0.7	9100		

\* Contattare nostro ufficio tecnico commerciale / \* Please, contact our technical sales dept. / \* Bitte setzen Sie sich mit unserer technischen Abteilung in Verbindung

P <sub>tN</sub>	P	R-L-F-FC-FU FB-FCB	M MX	FS FP	T
<b>701</b>	31.4	21.0	24.6	15.8	29.9
<b>702</b>	21.6	15.7	17.7	12.7	20.8
<b>703</b>	13.5	10.0	11.2	8.3	13.0
<b>704</b>	10.8	8.2	9.1	6.9	10.4

**1.2 Prestazioni**

**1.2 Performances**

**1.2 Leistungen**

	ir	n <sub>2</sub> X h							n <sub>1</sub> =1400 rpm h=10000 h		T <sub>max</sub> [Nm]	T <sub>FU</sub> [Nm]
		T <sub>N</sub> [Nm]							T <sub>N</sub> [Nm]	P <sub>1</sub> [kW]		
		10000	20000	50000	100000	500000	1000000	2000000				
EX..1	3.50	7836	7384	7234	7120	4949	4020	3265	2652	113.3	10800	<b>B</b>
	4.13	7719	7193	7075	6987	4909	3987	3239	2763	100.2	9650	
	5.17	6818	6163	6051	5966	4771	3876	3148	2874	83.2	9650	
	6.00	6659	6010	5900	5813	4602	3790	3079	2940	73.3	10200	
	7.25	6059	5560	4967	4392	3443	3284	3050	3082	63.6	8300	
EX..2	12.60	7836	7384	7234	7120	4949	4020	3265	3895	47.2	10800	
	14.88	7836	7384	7234	7120	4949	4020		4093	42.0	10800	
	17.53	7719	7193	7075	6987	4909	3987		4265	37.2	9650	
	18.60	6818	6163	6051	5966	4771	3876		4220	34.6	9650	
	22.00	7719	7193	7075	6987	4909	3987		4566	31.7	9650	
	25.58	7719	7193	6807	6509	4909	3987		4777	28.5	9650	
	27.56	6818	6163	6051	5966	4771	3876		4749	26.3	9650	
	32.03	6818	6163	6051	5966	4771			4968	23.7	9650	
	37.20	6659	6010	5900	5813	4602			4691	19.3	10200	
	38.75	6818	6163	6051	5966	4771			5260	20.7	9650	
	45.00	6659	6010	5900	5813	4602			4750	16.1	10200	
	54.38	6059	5560	4967	4392	3443			3595	10.1	8300	
EX..3	51.77	7836	7384	7234	7120	4730			5688	17.1	10800	
	53.72	7836	7384	7234	6701	4135			5027	14.6	10800	
	63.31	7719	7193	7075	6987				5925	14.6	9650	
	74.74	7719	7193	7075	6987				6590	13.8	9650	
	76.56	7719	7193	7075	6987				6638	13.5	9650	
	85.82	7836	7384	7234	7120				6312	11.5	10800	
	101.14	7719	7193	7075	6987				6945	10.7	9650	
	107.69	7836	7384	7234	7120				7077	10.2	10800	
	126.92	7719	7193	7075	6987				6974	8.6	9650	
	136.56	6818	6163	6051	5966				5963	6.8	9650	
	158.97	6818	6163	6051	5966				5982	5.9	9650	
	184.81	6818	6163	6051	5966				6000	5.1	9650	
	198.40	6818	6163	6051	5966				6009	4.7	9650	
	230.64	6818	6163	6051	5966				6027	4.1	9650	
	259.62	6659	6010	5900	5813				5891	3.5	10200	
279.00	6818	6163	6051	5966				6051	3.4	9650		
324.00	6659	6010	5900					5918	2.8	10200		
EX..4	180.14	7836	7384	7234					7200	6.4	10800	
	220.68	7836	7384	7234					7200	5.2	10800	
	260.09	7719	7193	7075					7000	4.3	9650	
	270.35	7836	7384	7234					7200	4.2	10800	
	318.62	7719	7193	7075					7000	3.5	9650	
	351.97	7719	7193	7075					7000	3.2	9650	
	386.75	7836	7384	7234					7200	3.0	10800	
	455.82	7719	7193	7075					7000	2.4	9650	
	495.10	7836	7384	7234					7200	2.3	10800	
	538.12	7719	7193	7075					7200	2.1	9650	
	643.13	6818	6163						6200	1.5	9650	
	728.22	7719	7193						7200	1.6	9650	
	802.63	6818	6163						6200	1.2	9650	
	917.16	6818	6163						6200	1.1	9650	
	1066.20	6818	6163						6200	0.93	9650	
	1144.62	6818	6163						6800	0.95	9650	
	1330.62	6818	6163						6800	0.81	9650	
	1428.48	6818	6163						6800	0.76	9650	
	1660.61	6818	6163						6800	0.65	9650	
	1869.23	6659	6010						6800	0.58	10200	
2008.80	6818	6163						6800	0.54	9650		
2332.80	6659	6010						6800	0.46	10200		

\* Contattare nostro ufficio tecnico commerciale / \* Please, contact our technical sales dept. / \* Bitte setzen Sie sich mit unserer technischen Abteilung in Verbindung

P <sub>TN</sub>	P	R-L-F-FC-FU FB-FCB	M MX	FS FP	T
<b>801</b>	42.2	27.7	29.4	20.1	40.5
<b>802</b>	28.7	20.4	21.4	16.0	27.7
<b>803</b>	17.6	12.8	13.4	10.2	17.1
<b>804</b>	13.9	10.3	10.7	8.4	13.5



## 1.2 Prestazioni

## 1.2 Performances

## 1.2 Leistungen

	ir	n <sub>2</sub> X h							n <sub>1</sub> =1400 rpm h=10000 h		T <sub>max</sub> [Nm]	T <sub>FU</sub> [Nm]																																																																																																																																																																																																																																																																																																																																																																																																																																														
		T <sub>N</sub> [Nm]							T <sub>N</sub> [Nm]	P <sub>1</sub> [kW]																																																																																																																																																																																																																																																																																																																																																																																																																																																
		10000	20000	50000	100000	500000	1000000	2000000																																																																																																																																																																																																																																																																																																																																																																																																																																																		
EX..2	12.60	9451	9326	9160	8808	5435	4414	3585	4277	51.8	15000	*																																																																																																																																																																																																																																																																																																																																																																																																																																														
	14.88	8793	8679	8528	8413	5356	4350		4430	45.5	15000																																																																																																																																																																																																																																																																																																																																																																																																																																															
	17.53	10332	9884	9716	9589	6009	4881		5221	45.5	13500																																																																																																																																																																																																																																																																																																																																																																																																																																															
	18.60	9202	8446	8287	8166	6540	5312		5785	47.5	12500																																																																																																																																																																																																																																																																																																																																																																																																																																															
	22.00	9455	9321	9144	9010	5830	4735		5423	37.6	13500																																																																																																																																																																																																																																																																																																																																																																																																																																															
	25.58	8085	7975	6807	6509	5768	4685		5613	33.5	13500																																																																																																																																																																																																																																																																																																																																																																																																																																															
	27.56	9202	8446	8287	8166	6540	5312		6509	36.1	12500																																																																																																																																																																																																																																																																																																																																																																																																																																															
	32.03	9202	8446	8287	8031	6540			6810	32.5	12500																																																																																																																																																																																																																																																																																																																																																																																																																																															
	37.20	9207	8266	8105	7983	6290			6420	26.4	13900																																																																																																																																																																																																																																																																																																																																																																																																																																															
	38.75	9202	8446	8287	8166	6540			7210	28.4	12500																																																																																																																																																																																																																																																																																																																																																																																																																																															
45.00	9207	8266	8105	7983	6290			6508	22.1	13900																																																																																																																																																																																																																																																																																																																																																																																																																																																
54.38	8369	7648	6826	5993	4622			4842	13.6	11400	EX..3		51.77	8793	8679	8528	7666	4730			5688	17.1	15000	53.72	9451	9326	8250	6701	4135			5027	14.6	15000	63.31	10637	9884	9255	7517				5925	14.6	13500	74.74	10332	9884	9716	8444				6995	14.6	13500	76.56	9455	9321	9144	9010				7883	16.1	13500	85.82	8793	8134	7559	7151				6312	11.5	15000	101.14	10001	9461	8793	8202				7439	11.5	13500	107.69	8049	7936	7786	7672				7629	11.0	15000	126.92	9455	9321	9144	9010				8991	11.0	13500	136.56	9202	8446	8287	8031				8017	9.2	12500	158.97	9202	8446	8287	8166				8188	8.0	12500	184.81	9202	8446	8287	8031				8181	6.9	12500	198.40	9202	8446	8287	8166				8227	6.5	12500	230.64	9202	8446	8287	8166				8253	5.6	12500	259.62	9207	8266	8105	7983				8091	4.9	13900	279.00	9202	8446	8287	8166				8286	4.6	12500	324.00	9207	8266	8105					8130	3.9	13900	EX..4	180.14	8793	8679	8528					8000	7.1	15000	220.68	8793	8679	8528					8000	5.8	15000	260.09	10332	9884	9716					9700	5.9	13500	270.35	8793	8679	8528					8500	5.0	15000	318.62	10332	9884	9716					9700	4.9	13500	351.97	10332	9884	9716					9700	4.4	13500	386.75	9451	9326	8250					8300	3.4	15000	455.82	10637	9884	9255					9300	3.3	13500	495.10	8793	8679	8528					8500	2.7	15000	538.12	10332	9884	9716					9700	2.9	13500	643.13	9202	8446						8500	2.1	12500	728.22	10332	9884						8500	1.9	13500	802.63	9202	8446						8500	1.7	12500	917.16	9202	8446						8500	1.5	12500	1066.20	9202	8446						8500	1.27	12500	1144.62	9202	8446						8500	1.18	12500	1330.62	9202	8446						9200	1.10	12500	1428.48	9202	8446						9200	1.03	12500	1660.61	9202	8446						9200	0.88	12500	1869.23	9207	8266						9200	0.78	13900	2008.80	9202	8446						9200	0.73	12500	2332.80	9207	8266						9200	0.63	13900
EX..3	51.77	8793	8679	8528	7666	4730			5688	17.1			15000																																																																																																																																																																																																																																																																																																																																																																																																																																													
	53.72	9451	9326	8250	6701	4135			5027	14.6			15000																																																																																																																																																																																																																																																																																																																																																																																																																																													
	63.31	10637	9884	9255	7517				5925	14.6			13500																																																																																																																																																																																																																																																																																																																																																																																																																																													
	74.74	10332	9884	9716	8444				6995	14.6			13500																																																																																																																																																																																																																																																																																																																																																																																																																																													
	76.56	9455	9321	9144	9010				7883	16.1			13500																																																																																																																																																																																																																																																																																																																																																																																																																																													
	85.82	8793	8134	7559	7151				6312	11.5			15000																																																																																																																																																																																																																																																																																																																																																																																																																																													
	101.14	10001	9461	8793	8202				7439	11.5			13500																																																																																																																																																																																																																																																																																																																																																																																																																																													
	107.69	8049	7936	7786	7672				7629	11.0			15000																																																																																																																																																																																																																																																																																																																																																																																																																																													
	126.92	9455	9321	9144	9010				8991	11.0		13500																																																																																																																																																																																																																																																																																																																																																																																																																																														
	136.56	9202	8446	8287	8031				8017	9.2		12500																																																																																																																																																																																																																																																																																																																																																																																																																																														
	158.97	9202	8446	8287	8166				8188	8.0		12500																																																																																																																																																																																																																																																																																																																																																																																																																																														
	184.81	9202	8446	8287	8031				8181	6.9		12500																																																																																																																																																																																																																																																																																																																																																																																																																																														
	198.40	9202	8446	8287	8166				8227	6.5		12500																																																																																																																																																																																																																																																																																																																																																																																																																																														
	230.64	9202	8446	8287	8166				8253	5.6	12500																																																																																																																																																																																																																																																																																																																																																																																																																																															
259.62	9207	8266	8105	7983				8091	4.9	13900																																																																																																																																																																																																																																																																																																																																																																																																																																																
279.00	9202	8446	8287	8166				8286	4.6	12500																																																																																																																																																																																																																																																																																																																																																																																																																																																
324.00	9207	8266	8105					8130	3.9	13900																																																																																																																																																																																																																																																																																																																																																																																																																																																
EX..4	180.14	8793	8679	8528					8000	7.1	15000																																																																																																																																																																																																																																																																																																																																																																																																																																															
	220.68	8793	8679	8528					8000	5.8	15000																																																																																																																																																																																																																																																																																																																																																																																																																																															
	260.09	10332	9884	9716					9700	5.9	13500																																																																																																																																																																																																																																																																																																																																																																																																																																															
	270.35	8793	8679	8528					8500	5.0	15000																																																																																																																																																																																																																																																																																																																																																																																																																																															
	318.62	10332	9884	9716					9700	4.9	13500																																																																																																																																																																																																																																																																																																																																																																																																																																															
	351.97	10332	9884	9716					9700	4.4	13500																																																																																																																																																																																																																																																																																																																																																																																																																																															
	386.75	9451	9326	8250					8300	3.4	15000																																																																																																																																																																																																																																																																																																																																																																																																																																															
	455.82	10637	9884	9255					9300	3.3	13500																																																																																																																																																																																																																																																																																																																																																																																																																																															
	495.10	8793	8679	8528					8500	2.7	15000																																																																																																																																																																																																																																																																																																																																																																																																																																															
	538.12	10332	9884	9716					9700	2.9	13500																																																																																																																																																																																																																																																																																																																																																																																																																																															
	643.13	9202	8446						8500	2.1	12500																																																																																																																																																																																																																																																																																																																																																																																																																																															
	728.22	10332	9884						8500	1.9	13500																																																																																																																																																																																																																																																																																																																																																																																																																																															
	802.63	9202	8446						8500	1.7	12500																																																																																																																																																																																																																																																																																																																																																																																																																																															
	917.16	9202	8446						8500	1.5	12500																																																																																																																																																																																																																																																																																																																																																																																																																																															
	1066.20	9202	8446						8500	1.27	12500																																																																																																																																																																																																																																																																																																																																																																																																																																															
	1144.62	9202	8446						8500	1.18	12500																																																																																																																																																																																																																																																																																																																																																																																																																																															
	1330.62	9202	8446						9200	1.10	12500																																																																																																																																																																																																																																																																																																																																																																																																																																															
	1428.48	9202	8446						9200	1.03	12500																																																																																																																																																																																																																																																																																																																																																																																																																																															
	1660.61	9202	8446						9200	0.88	12500																																																																																																																																																																																																																																																																																																																																																																																																																																															
	1869.23	9207	8266						9200	0.78	13900																																																																																																																																																																																																																																																																																																																																																																																																																																															
2008.80	9202	8446						9200	0.73	12500																																																																																																																																																																																																																																																																																																																																																																																																																																																
2332.80	9207	8266						9200	0.63	13900																																																																																																																																																																																																																																																																																																																																																																																																																																																

\* Contattare nostro ufficio tecnico commerciale / \* Please, contact our technical sales dept. / \* Bitte setzen Sie sich mit unserer technischen Abteilung in Verbindung

P <sub>TN</sub>	P	R-L-F-FC-FU FB-FCB	M MX	FS FP	T
902	30.4	25.6	4.6	16.9	28.6
903	18.6	15.8	3.6	10.8	17.6
904	14.6	12.6	3.3	8.7	13.9

**1.2 Prestazioni**

**1.2 Performances**

**1.2 Leistungen**

	ir	n <sub>2</sub> X h							n <sub>1</sub> =1400 rpm h=10000 h		T <sub>max</sub> [Nm]	T <sub>FU</sub> [Nm]
		T <sub>N</sub> [Nm]							T <sub>N</sub> [Nm]	P <sub>1</sub> [kW]		
		10000	20000	50000	100000	500000	1000000	2000000				
EX..1	3.50	10752	10107	9893	9731	6784	5510	4476	3635	155.4	15000	<b>B</b>
	4.13	10637	9884	9716	9589	6729	5465	4439	3788	137.4	13500	
	5.17	9202	8446	8287	8166	6540	5312	4315	3939	114.1	12500	
	6.00	9207	8266	8105	7983	6290	5196	4220	4029	100.5	13900	
	7.25	8369	7648	6826	5993	4622	4392	4162	4173	86.1	11400	
EX..2	12.60	10752	10107	9893	9731	6784	5510	4476	5339	64.7	15000	
	14.88	10752	10107	9893	9731	6784	5510		5611	57.6	15000	
	17.53	10637	9884	9716	9589	6729	5465		5847	50.9	13500	
	18.60	9202	8446	8287	8166	6540	5312		5785	47.5	12500	
	22.00	10637	9884	9716	9589	6729	5465		6259	43.4	13500	
	25.58	10637	9884	9716	9589	6729	5465		6548	39.1	13500	
	27.56	9202	8446	8287	8166	6540	5312		6509	36.1	12500	
	32.03	9202	8446	8287	8166	6540			6810	32.5	12500	
	37.20	9207	8266	8105	7983	6290			6420	26.4	13900	
	38.75	9202	8446	8287	8166	6540			7210	28.4	12500	
	45.00	9207	8266	8105	7983	6290			6508	22.1	13900	
54.38	8369	7648	6826	5993	4622			4842	13.6	11400		
EX..3	51.77	10752	10107	9893	9731	6784			8157	24.6	15000	
	53.72	10752	10107	9893	9731	6784			8248	23.9	15000	
	63.31	10637	9884	9716	9589				8594	21.2	13500	
	74.74	10637	9884	9716	9589				9033	18.8	13500	
	76.56	10637	9884	9716	9589				9099	18.5	13500	
	85.82	10752	10107	9893	9731				9493	17.3	15000	
	101.14	10637	9884	9716	9589				9530	14.7	13500	
	107.69	10045	9944	9811	9710				9669	14.0	15000	
	126.92	10637	9884	9716	9589				9571	11.8	13500	
	136.56	9202	8446	8287	8166				8162	9.3	12500	
	158.97	9202	8446	8287	8166				8188	8.0	12500	
	184.81	9202	8446	8287	8166				8215	6.9	12500	
	198.40	9202	8446	8287	8166				8227	6.5	12500	
	230.64	9202	8446	8287	8166				8253	5.6	12500	
	259.62	9207	8266	8105	7983				8091	4.9	13900	
279.00	9202	8446	8287	8166				8286	4.6	12500		
324.00	9207	8266	8105					8130	3.9	13900		
EX..4	180.14	10752	10107	9893					9700	8.6	15000	
	220.68	10752	10107	9893					9700	7.0	15000	
	260.09	10637	9884	9716					9700	5.9	13500	
	270.35	10752	10107	9893					9800	5.8	15000	
	318.62	10637	9884	9716					9800	4.9	13500	
	351.97	10637	9884	9716					9800	4.4	13500	
	386.75	10752	10107	9893					9800	4.0	15000	
	455.82	10637	9884	9716					9800	3.4	13500	
	495.10	10752	10107	9893					9800	3.2	15000	
	538.12	10637	9884	9716					9800	2.9	13500	
	643.13	9202	8446						8500	2.1	12500	
	728.22	10637	9884						9800	2.1	13500	
	802.63	9202	8446						8500	1.7	12500	
	917.16	9202	8446						8500	1.5	12500	
	1066.20	9202	8446						8500	1.27	12500	
	1144.62	9202	8446						8500	1.18	12500	
	1330.62	9202	8446						9200	1.10	12500	
	1428.48	9202	8446						9200	1.03	12500	
	1660.61	9202	8446						9200	0.88	12500	
	1869.23	9207	8266						9200	0.78	13900	
2008.80	9202	8446						9200	0.73	12500		
2332.80	9207	8266						9200	0.63	13900		

\* Contattare nostro ufficio tecnico commerciale / \* Please, contact our technical sales dept. / \* Bitte setzen Sie sich mit unserer technischen Abteilung in Verbindung

P <sub>TN</sub>	P	R-L-F-FC-FU FB-FCB	FS FP	T
<b>1001</b>	45.2	36.9	21.6	42.1
<b>1002</b>	31.1	26.4	17.7	29.4
<b>1003</b>	20.3	17.5	12.5	19.3
<b>1004</b>	15.9	13.8	10.0	15.1





## 1.2 Prestazioni

## 1.2 Performances

## 1.2 Leistungen

	ir	n <sub>2</sub> X h							n <sub>1</sub> =1400 rpm h=10000 h		T <sub>max</sub> [Nm]	T <sub>FU</sub> [Nm]
		T <sub>N</sub> [Nm]							T <sub>N</sub> [Nm]	P <sub>1</sub> [kW]		
		10000	20000	50000	100000	500000	1000000	2000000				
EX..1	4.09	18257	17249	16917	16665	11182	9083	7377	6279	229.6	26000	
	5.25	18420	17081	16797	16583	10913	8864	7200	6605	188.2	23000	
	6.23	17333	15583	13699	11959	9630	8651	7027	6786	162.9	24000	
EX..2	14.73	18257	17249	16917	16665	10641	8643	7021	8776	91.0	26000	
	17.39	18257	17249	16917	16665	10487	8518		9090	79.8	26000	
	21.82	17916	17249	16917	16490	10175	8264		9441	66.1	23000	
	25.36	15254	15036	13236	12641	10067	8177		9773	58.8	26000	
	28.00	18420	17081	16797	16583	10913	8864		10913	59.5	23000	
	32.55	18420	17081	16711	15947	10913			11417	53.6	24000	
	33.23	17333	15583	13699	11959	9630			9743	44.8	26000	
	39.38	17087	15101	12488	11945	10683			10950	42.5	24000	
46.73	17333	15583	13699	11959	9630			9967	32.6	23000		
EX..3	51.25	18257	17249	16917	13940	8601			10312	31.4	26000	
	60.50	18257	17249	16917	15657	9661			12173	31.4	23000	
	62.78	18257	17249	16848	13685				10759	26.7	24000	
	74.12	18257	17249	16917	15371				12701	26.7	23000	
	80.57	18420	17081	16797	16296				13807	26.7	26000	
	93.01	17916	17249	16917	16490				14586	24.5	23000	
	100.31	18257	17249	16917	14931				13509	21.0	26000	
	109.04	18420	17081	16797	15829				14685	21.0	24000	
	125.87	17916	17249	16917	16490				15972	19.8	23000	
	146.33	15254	15036	13236	12641				12678	13.5	26000	
	157.09	17395	15677	14333	13845				13925	13.8	23000	
	182.62	15254	15036	13236	12641				12869	11.0	24000	
	201.60	18420	17081	16797	16583				16695	12.9	26000	*
	234.36	18420	17081	16711	15947				16515	11.0	24000	
239.26	17333	15583	13699	11959				13305	8.7	24000		
278.14	17333	15583	13699	11959				13683	7.7	26000		
EX..4	210.56	18257	17249	16917	13940				15000	11.4	26000	
	218.49	18257	17249	16917	13940				15000	10.9	26000	
	257.94	18257	17249	16917	13940				15000	9.3	26000	
	280.40	18420	17081	16797	16296				17000	9.7	23000	
	315.99	18257	17249	16917					17000	8.6	26000	
	349.06	18257	17249	16917					17000	7.8	26000	
	396.53	18257	17249	16917					17000	6.8	26000	
	452.05	18257	17249	16917					17000	6.0	26000	
	508.89	18420	17081	16797					17000	5.3	23000	
	578.69	18257	17249	16917					17000	4.7	26000	
	629.07	18420	17081						17000	4.3	23000	
	722.20	18257	17249						17000	3.8	26000	
	800.57	18420	17081						17000	3.4	23000	
	906.29	18257	17249						17000	3.0	26000	
	999.11	18420	17081						17000	2.7	23000	
	1156.68	18420	17081						17000	2.34	23000	
	1285.79	17333	15583						17000	2.11	24000	
	1451.52	18420	17081						18500	2.03	23000	
1635.58	18420	17081						18500	1.80	23000		
1722.68	17333	15583						17000	1.57	24000		
2041.20	18420	17081						18500	1.44	23000		

\* Contattare nostro ufficio tecnico commerciale / \* Please, contact our technical sales dept. / \* Bitte setzen Sie sich mit unserer technischen Abteilung in Verbindung

P <sub>IN</sub>	P	PH	PX	R-L-F-FC- FU FB-FCB	FS FP	H HU	X	T
<b>1501</b>	64.9	54.7	63.5	39.6	26.7	32.7	41.5	58.1
<b>1502</b>	44.4	38.6	43.6	29.9	22.6	26.0	31.0	40.5
<b>1503</b>	28.0	22.5	27.6	19.6	15.3	17.3	20.2	25.8
<b>1504</b>	21.7	19.2	21.4	15.4	12.1	13.6	15.8	20.0



**1.2 Prestazioni**

**1.2 Performances**

**1.2 Leistungen**

	ir	n <sub>2</sub> X h							n <sub>1</sub> =1400 rpm h=10000 h		T <sub>max</sub> [Nm]	T <sub>FU</sub> [Nm]
		T <sub>N</sub> [Nm]							T <sub>N</sub> [Nm]	P <sub>1</sub> [kW]		
		10000	20000	50000	100000	500000	1000000	2000000				
EX..2	14.73	18257	17249	16917	16665	11182	9083	7377	9222	95.6	26000	*
	18.90	18420	17081	16797	16583	10913	8864		9699	78.4	23000	
	22.43	17333	15583	13699	11959	9630	8651		9484	64.6	24000	
EX..3	62.78	18257	17249	16917	16665	11182			14247	35.4	26000	
	80.57	18420	17081	16797	16583	10913			14985	29.0	23000	
	95.63	17333	15583	13699	11959				11002	17.9	24000	
EX..4	218.49	18257	17249	16917	16665				16800	12.3	26000	
	267.66	18257	17249	16917	16665				16800	10.0	26000	
	280.40	18420	17081	16797	16583				16800	9.5	23000	
	332.78	17333	15583	13699	11959				14000	6.7	24000	
	343.50	18420	17081	16797	16583				16800	7.8	23000	
	362.22	18257	17249	16917	16665				16800	7.4	26000	
	407.67	17333	15583	13699	11959				14000	5.5	24000	
	452.05	18257	17249	16917	16665				16800	5.9	26000	
	464.85	18420	17081	16797	16583				16800	5.8	23000	
	551.69	17333	15583	13699	11959				15500	4.5	24000	
	580.13	18420	17081	16797	16583				17000	4.7	23000	
688.51	17333	15583	13699	11959				15500	3.6	24000		

**B**

\* Contattare nostro ufficio tecnico commerciale / \* Please, contact our technical sales dept. / \* Bitte setzen Sie sich mit unserer technischen Abteilung in Verbindung

P <sub>tN</sub>	P	PH	PX	R-L-F-FC-FU FB-FCB	FS FP	H HU	X	T
<b>1802</b>	44.3	38.6	43.6	29.9	22.6	26.0	31.0	40.5
<b>1803</b>	28.0	22.5	27.6	19.6	15.3	17.3	20.2	25.8
<b>1804</b>	21.6	19.2	21.4	15.4	12.1	13.6	15.8	20.0



## 1.2 Prestazioni

## 1.2 Performances

## 1.2 Leistungen

	ir	n <sub>2</sub> X h							n <sub>1</sub> =1400 rpm h=10000 h		T <sub>max</sub> [Nm]	T <sub>FU</sub> [Nm]
		T <sub>N</sub> [Nm]							T <sub>N</sub> [Nm]	P <sub>1</sub> [kW]		
		10000	20000	50000	100000	500000	1000000	2000000				
EX..1	4.00	32628	30807	30108	26912	16606	13488	10956	9263	346.4	51500	
	5.20	31767	29519	29041	26516	16361	13290	10795	9874	284.0	36700	
	6.25	25999	24178	23770	21693	16050	13036	10589	10235	245.0	35200	
EX..2	14.00	28384	27940	25433	20658	12747	10353	8410	10353	112.9	51500	
	16.50	27734	27387	25226	20490	12643	10269		10788	99.8	51500	
	18.20	31767	29519	29041	24823	15316	12441		13460	112.9	36700	
	21.45	31767	29519	29041	24621	15192	12340		14025	99.8	36700	
	26.87	30686	29519	29041	23933	14767	11995		14585	82.9	36700	
	31.20	29921	29288	24389	23295	14442	11731		14919	73.0	36700	
	37.70	25044	22124	18235	17429	14307			15642	63.4	36700	
45.31	25999	24178	21660	20691	16050			17824	60.1	35200		
EX..3	50.40	28384	27940	25433	20658	12747			15205	47.0	51500	
	59.40	27734	27387	25226	20490	12643			15843	41.6	51500	
	70.13	27734	27387	25226	20490				16652	37.0	51500	
	77.35	31767	29519	29041	24823				20775	41.9	36700	
	87.83	23729	23399	22963	19917				17318	30.7	51500	
	102.30	27734	25785	24244	20490				18650	28.4	51500	
	114.18	30686	29519	29041	23933				22513	30.7	36700	
	132.60	29921	29288	24389	23295				23027	27.1	36700	
	143.29	30686	29519	29041	23933				24100	26.2	36700	
	166.57	30686	29519	29041	23933				25213	23.6	36700	
	193.44	29921	29288	24389	23295				23806	19.2	36700	
	201.50	30686	29519	28718	23933				26548	20.5	36700	
	233.74	25044	22124	18235	17429				18025	12.0	36700	*
	242.19	25999	24178	23770	21693				23705	15.3	35200	
282.75	25044	22124	18235	17429				18246	10.1	36700		
339.84	25999	24178	21660					21930	10.1	35200		
EX..4	207.06	28384	27940	25433					23000	17.7	51500	
	214.86	28384	27940	25433					23000	17.1	51500	
	244.04	28384	27940	25433					23000	15.0	51500	
	298.95	28384	27940	25433					25000	13.3	51500	
	306.24	28384	27940	25433					25000	13.0	51500	
	342.69	28384	27940	25433					25000	11.6	51500	
	404.57	28384	27940	25433					25000	9.8	51500	
	445.50	31767	29519	29041					29000	10.4	36700	
	506.73	28384	27940	25433					27000	8.5	51500	
	558.00	31767	29519	29041					29000	8.3	36700	
	633.60	28384	27940						27000	6.8	51500	
	698.88	31767	29519						29000	6.6	36700	
	824.67	31767	29519						29000	5.6	36700	
	922.56	28384	27940						28000	4.8	51500	
	1031.68	31767	29519						30000	4.6	36700	
	1162.50	31767	29519						30000	4.1	36700	
	1350.00	31767	29519						30000	3.5	36700	
1450.80	31767	29519						31800	3.5	36700		
1684.80	31767	29519						31800	3.0	36700		
2035.80	31767	29519						31800	2.5	36700		

\* Contattare nostro ufficio tecnico commerciale / \* Please, contact our technical sales dept. / \* Bitte setzen Sie sich mit unserer technischen Abteilung in Verbindung

P <sub>TN</sub>	PH	FCB	FS FP	H HU	T
<b>2501</b>	61.8	41.8	33.4	36.6	57.1
<b>2502</b>	45.4	34.0	29.2	31.0	42.7
<b>2503</b>	26.5	22.5	19.7	20.8	27.6
<b>2504</b>	22.5	17.5	15.4	16.2	21.4

**1.2 Prestazioni**

**1.2 Performances**

**1.2 Leistungen**

	ir	n <sub>2</sub> X h							n <sub>1</sub> =1400 rpm h=10000 h		T <sub>max</sub> [Nm]	T <sub>FU</sub> [Nm]
		T <sub>N</sub> [Nm]							T <sub>N</sub> [Nm]	P <sub>1</sub> [kW]		
		10000	20000	50000	100000	500000	1000000	2000000				
EX..2	14.00	32628	30807	30108	26912	16606	13488	10956	13488	147.1	51500	
	16.50	32628	30807	30108	26912	16606	13488		14170	131.1	51500	
	18.20	31767	29519	29041	26516	16361	13290		14378	120.6	36700	
	21.45	31767	29519	29041	26516	16361	13290		15104	107.5	36700	
	26.87	31767	29519	29041	26516	16361	13290		16160	91.8	36700	
	31.20	31767	29519	29041	26516	16361	13290		16901	82.7	36700	
	37.70	31767	29519	24558	23390	16361			17889	72.5	36700	
	45.31	25999	24178	23770	21693	16050			17824	60.1	35200	
EX..3	50.40	32628	30807	27929	22685	13998			16697	51.7	51500	
	59.40	32628	30807	30108	25450	15704			19678	51.7	51500	
	70.13	32628	30807	30108	25082				20384	45.3	51500	
	77.35	31767	29519	29041	26516				22193	44.7	36700	
	87.83	32503	30807	30108	26912				23400	41.5	51500	
	102.30	28781	25785	24244	23078				21914	33.4	51500	
	114.18	31767	29519	29041	26516				24943	34.1	36700	
	132.60	31767	29519	29041	26516				26088	30.7	36700	
	143.29	31767	29519	29041	26516				26702	29.1	36700	
	166.57	31767	29519	29041	26516				27935	26.2	36700	
	193.44	31767	29519	29041	26516				28848	23.3	36700	
	201.50	31767	29519	28718	26516				28054	21.7	36700	
	233.74	31767	29519	24558	23390				24254	16.2	36700	
	242.19	25999	24178	23770	21693				23705	15.3	35200	
282.75	31767	29519	24558	23390				24575	13.6	36700		
339.84	25999	24178	23770					23856	10.9	35200		
EX..4	207.06	32628	30807	27929					25000	19.2	51500	
	214.86	32628	30807	27929					25000	18.5	51500	
	244.04	32628	30807	27929					25000	16.3	51500	
	298.95	32628	30807	27929					28000	14.9	51500	
	306.24	32628	30807	27929					28000	14.6	51500	
	342.69	32628	30807	27929					28000	13.0	51500	
	404.57	32628	30807	27929					28000	11.0	51500	
	445.50	31767	29519	29041					29000	10.4	36700	
	506.73	32628	30807	27929					28000	8.8	51500	
	558.00	31767	29519	29041					29000	8.3	36700	
	633.60	32628	30807						30000	7.5	51500	
	698.88	31767	29519						30000	6.8	36700	
	824.67	31767	29519						30000	5.8	36700	
	922.56	32628	30807						30000	5.2	51500	
	1031.68	31767	29519						30000	4.6	36700	
	1162.50	31767	29519						30000	4.1	36700	
	1350.00	31767	29519						32000	3.8	36700	
	1450.80	31767	29519						32000	3.5	36700	
1684.80	31767	29519						32000	3.0	36700		
2035.80	31767	29519						32000	2.5	36700		

**B**

\* Contattare nostro ufficio tecnico commerciale / \* Please, contact our technical sales dept. / \* Bitte setzen Sie sich mit unserer technischen Abteilung in Verbindung

P <sub>TN</sub>	PH	FCB	FS FP	H HU	T
<b>2802</b>	46.3	34.9	30.1	31.9	43.6
<b>2803</b>	27.0	23.5	20.7	21.7	28.6
<b>2804</b>	23.3	18.3	16.2	17.0	22.1



## 1.2 Prestazioni

## 1.2 Performances

## 1.2 Leistungen

	ir	n <sub>2</sub> X h							n <sub>1</sub> =1400 rpm h=10000 h		T <sub>max</sub> [Nm]	T <sub>FU</sub> [Nm]
		T <sub>N</sub> [Nm]							T <sub>N</sub> [Nm]	P <sub>1</sub> [kW]		
		10000	20000	50000	100000	500000	1000000	2000000				
EX..1	4.00	40352	38077	36691	35805	22141	17984	14608	12350	461.9	65000	*
	4.71	38455	37838	37021	36035	22115	17963	14591	12952	411.7	64000	
EX..2	14.00	38826	38077	34862	28317	17473	14192		14192	154.8	65000	
	16.47	38455	37838	37021	31729	19578	15902		16697	154.8	64000	
	19.41	38455	37838	37021	31471	19419	15773		17398	136.9	64000	
	24.31	38109	37555	36823	30591	18876	15332		18093	113.6	64000	
	28.24	37273	36713	30476	29018	18460	14994		18507	100.1	64000	
EX..3	34.12	31688	27858	22377	21320	18287			19167	85.8	64000	
	50.40	35920	35431	34784	28317	17473			20842	64.5	65000	
	59.29	38455	37838	37021	31729	19578			24520	64.5	64000	
	70.00	38455	37838	37021	31729	19578			25772	57.4	64000	
	82.50	38455	37838	37021	31471				26854	50.8	64000	
	87.53	38109	37555	36823	30591				26571	47.3	64000	
	101.65	37273	36713	30476	29018				27178	41.7	64000	
	110.22	32503	32033	31410	27302				25412	36.0	65000	
	120.00	37273	36713	30476	29018				28566	37.1	64000	
	129.67	38109	37555	36823	30591				29896	36.0	64000	
	150.75	38109	37035	34764	30591				31277	32.4	64000	
	175.06	37273	36713	30476	29018				29488	26.3	64000	
211.76	33486	32017	30075	28606				29483	21.7	64000		
255.88	31688	27858	22377	21320				22240	13.6	64000		
EX..4	206.34	38455	37838	37021	31729				36000	27.2	64000	
	214.86	35920	35431	34784	28317				34000	25.2	65000	
	243.60	38455	37838	37021	31729				36500	23.9	64000	
	298.42	38455	37838	37021	31729				37500	20.0	64000	
	304.60	38109	37555	36823	30591				37000	19.4	64000	
	342.08	38455	37838	37021	31729				37500	17.5	64000	
	403.85	38455	37838	37021					37000	14.6	64000	
	451.26	38109	37555	36823					37000	13.1	64000	
	504.98	38109	37555	36823					37000	11.7	64000	
	552.82	38109	37555	36823					37000	10.7	64000	
	630.21	38109	37555	36823					37000	9.4	64000	
	736.94	33486	32017						32000	6.9	64000	
	775.73	31688	27858						28000	5.8	64000	
	869.68	38109	37035						37500	6.9	64000	
	933.65	38109	37555						27800	4.7	64000	
	1085.36	35920	35431						36000	5.3	64000	
	1260.42	37273	36713						37000	4.7	64000	
	1310.12	31688	27858						31500	3.8	64000	
1524.71	32017	36823						32000	3.3	64000		
1842.35	31688	27858						32000	2.8	64000		

\* Contattare nostro ufficio tecnico commerciale / \* Please, contact our technical sales dept. / \* Bitte setzen Sie sich mit unserer technischen Abteilung in Verbindung

P <sub>tN</sub>	PH	FS FP	H HU	T
<b>3001</b>	64.3	32.7	36.6	73.7
<b>3002</b>	47.7	29.6	31.9	53.1
<b>3003</b>	27.8	20.4	21.7	34.1
<b>3004</b>	23.9	16.0	17.0	26.2

**1.2 Prestazioni**

**1.2 Performances**

**1.2 Leistungen**

	ir	n <sub>2</sub> X h							n <sub>1</sub> =1400 rpm h=10000 h		T <sub>max</sub> [Nm]	T <sub>FU</sub> [Nm]		
		T <sub>N</sub> [Nm]							T <sub>N</sub> [Nm]	P <sub>1</sub> [kW]				
		10000	20000	50000	100000	500000	1000000	2000000						
EX..1	4.18	46922	44200	43363	42730	30452	24735	20091	17214	615.8	85000			
	4.89	47811	44245	43485	42910	29855	24250	19697	17686	541.2	82000			
	6.00	44300	40410	39746	39244	29427	23902	19415	18537	462.2	80000			
EX..2	17.11	46922	44200	43363	42730	29711	24133	19602	25629	228.8	85000			
	20.00	47811	44245	43485	42910	29855	24250		26989	206.1	82000			
	21.95	46922	44200	43363	42730	28997	23553		26957	187.5	85000			
	25.67	47811	44245	43485	42910	29855	24250		29086	173.0	82000			
	30.46	47811	44245	43485	42910	29855	24250		30619	153.5	82000			
EX..3	37.38	44300	40410	39746	39244	29427	23902		32093	131.1	80000			
	61.59	46922	44200	43363	42730	28275	22966		35817	90.7	85000			
	72.00	47811	44245	43485	42910	29855			39634	85.8	82000			
	79.04	46922	44200	43363	42730	28997			39588	78.1	85000			
	85.00	47811	44245	43485	42910				41658	76.4	82000			
	92.40	47811	44245	43485	42910				42566	71.8	82000			
	106.67	47811	44245	43485	42910				42685	62.4	82000			
	109.66	47811	44245	43485	42910				42708	60.7	82000			
	124.00	47811	44245	43485	42910				42809	53.8	82000			
	136.89	47811	44245	43485	42910				42891	48.9	82000			
	150.00	47225	44245	42534	40513				40714	42.3	82000			
	159.13	47811	44245	43485	42910				43016	42.2	82000			
	184.09	44300	40410	39746	39244				39443	33.4	80000			
	192.50	47811	44245	43485	42910				43174	35.0	82000			
	199.38	44300	40410	39746	39244				39500	30.9	80000			
	228.46	47811	44245	43485	42910				43316	29.6	82000			
	236.25	44300	40410	39746	39244				39623	26.2	80000			
	280.38	44300	40410	39746	39244				39747	22.1	80000			
	EX..4	214.32	46922	44200	43363	42730				43000	32.0		85000	
		250.56	47811	44245	43485	42910				43500	27.7		82000	
295.80		47811	44245	43485	42910				43500	23.4	82000			
306.95		47811	44245	43485	42910				43500	22.6	82000			
321.55		47811	44245	43485	42910				43500	21.6	82000			
362.37		47811	44245	43485	42910				44000	19.3	82000			
415.38		47811	44245	43485	42910				44000	16.9	82000			
454.74		47811	44245	43485					46000	16.1	82000			
518.40		47811	44245	43485					46500	14.3	82000			
553.78		47811	44245	43485					47500	13.7	82000			
611.92		47811	44245	43485					48800	12.7	82000			
715.38		47811	44245	43485					48000	10.7	82000			
820.66		47811	44245	43485					45000	8.7	82000			
918.08		47811	44245	43485					46000	8.0	82000			
1007.17		44300	40410	39746					46000	7.3	80000			
1110.58		47811	44245	43485					46500	6.7	82000			
1318.05		47811	44245						47500	5.7	82000			
1386.00		47811	44245						48800	5.6	82000			
1644.92	47811	44245						48000	4.6	82000				
1701.00	44300	40410						45000	4.2	80000				
2018.77	44300	40410						46000	3.6	80000				

**B**

\*

\* Contattare nostro ufficio tecnico commerciale / \* Please, contact our technical sales dept. / \* Bitte setzen Sie sich mit unserer technischen Abteilung in Verbindung

P <sub>TN</sub>	PS PSB	S-SB-SU FS-FSB
<b>4201</b>	91.3	47.9
<b>4202</b>	49.1	32.8
<b>4203</b>	35.8	25.0
<b>4204</b>	28.5	20.3



## 1.2 Prestazioni

## 1.2 Performances

## 1.2 Leistungen

	ir	n <sub>2</sub> X h							n <sub>1</sub> =1400 rpm h=10000 h		T <sub>max</sub> [Nm]	T <sub>FU</sub> [Nm]
		T <sub>N</sub> [Nm]							T <sub>N</sub> [Nm]	P <sub>1</sub> [kW]		
		10000	20000	50000	100000	500000	1000000	2000000				
EX..1	4.18	66723	62817	61580	60644	38889	31588	25657	21983	786.4	120000	
	4.89	67095	61932	60499	59747	38401	31191	25335	22749	696.1	117000	
	6.00	60279	57012	55884	55030	37694	30617	24869	23745	592.0	117000	
EX..2	16.73	66723	62817	61580	60644	38889	31588		33320	304.2	120000	
	19.56	67095	61932	60499	59747	38401	31191		34481	269.3	117000	
	21.75	66723	62817	61580	60644	38889	31588		36049	253.1	120000	
	26.14	66723	62817	61580	60644	38889	31588		38094	222.6	120000	
	30.56	67095	61932	60499	59747	38401	31191		39420	197.0	117000	
	37.50	60279	57012	55884	55030	37694	30617		41146	167.6	117000	
EX..3	68.44	67095	61932	60499	59747	37783			49402	112.6	117000	
	76.11	66723	62817	61580	60644	38889			52494	107.6	120000	
	80.67	67095	61932	60499	59747	37476			51477	99.5	117000	
	89.70	66723	62817	61580	60644				55147	95.9	120000	
	99.00	60279	57012	55884	55030				53083	83.6	117000	
	107.81	66723	62817	61580	60644				58275	84.3	120000	
	126.04	67095	61932	60499	59747				59633	73.8	117000	
	135.04	66723	62817	61580	60644				60595	70.0	120000	
	152.53	67095	61932	60499	59747				59840	61.2	117000	
	157.87	67095	61932	60499	59747				59877	59.2	117000	
	174.00	60279	57012	55884	55030				55297	49.6	117000	
	184.31	67095	61932	60499	59747				60045	50.8	117000	
	189.49	66723	62817	61580	60644				61053	50.2	120000	
	221.53	67095	61932	60499	59747				60245	42.4	117000	
271.88	60279	57012	55884	55030				55847	32.0	117000		
EX..4	246.40	67095	61932	60499	59747				60000	38.8	117000	
	273.99	67095	61932	60499	59747				60500	35.2	117000	
	323.46	67095	61932	60499					61000	30.0	117000	
	365.04	67095	61932	60499					61000	26.6	117000	
	405.92	67095	61932	60499					61500	24.1	117000	
	453.75	67095	61932	60499					61700	21.7	117000	
	535.68	67095	61932	60499					61900	18.4	117000	
	573.91	66723	62817	61580					62500	17.4	118000	
	648.27	67095	61932	60499					62000	15.2	117000	
	720.20	66723	62817						63000	13.9	118000	
	805.33	66723	62817						63500	12.6	118000	
	945.71	67095	61932						63500	10.7	117000	
	1010.61	66723	62817						63500	10.0	118000	
	1144.00	67095	61932						64000	8.9	117000	
	1305.00	60279	57012						60000	7.3	117000	
	1375.00	67095	61932						67000	7.8	117000	
	1421.16	66723	62817						66800	7.5	118000	
	1661.46	67095	61932						68000	6.5	117000	
2039.06	60279	57012						62000	4.8	117000		

\* Contattare nostro ufficio tecnico commerciale / \* Please, contact our technical sales dept. / \* Bitte setzen Sie sich mit unserer technischen Abteilung in Verbindung

P <sub>tn</sub>	PS PSB	S-SB-SU FS-FSB
<b>6501</b>	117.0	65.2
<b>6502</b>	64.3	44.9
<b>6503</b>	48.8	35.8
<b>6504</b>	38.6	28.8

**1.2 Prestazioni**

**1.2 Performances**

**1.2 Leistungen**

	ir	n <sub>2</sub> X h							n <sub>1</sub> =1400 rpm h=10000 h		T <sub>max</sub> [Nm]	T <sub>FU</sub> [Nm]
		T <sub>N</sub> [Nm]							T <sub>N</sub> [Nm]	P <sub>1</sub> [kW]		
		10000	20000	50000	100000	500000	1000000	2000000				
EX..1	4.18	88361	82056	80656	79597	53235	43240	35122	30092	1076.4	170000	*
	4.89	89324	82360	79855	78791	52013	42248	34316	30813	942.8	160000	
	6.00	82807	75822	72518	65903	50855	41307	33552	32036	798.7	150000	
EX..2	16.73	88361	82056	80656	79597	53235	43240	35122	45611	416.4	170000	
	19.70	88361	82056	80656	79597	53235	43240		47903	371.4	170000	
	23.03	89324	82360	79855	78791	52013	42248		49050	325.3	160000	
	28.26	82807	75822	72518	65903	50855	41307		50997	275.6	150000	
EX..3	68.94	88361	82056	80656	79597	42226			68206	154.3	170000	
	81.25	88361	82056	80656	79597	42226			71070	136.4	170000	
	86.42	88361	82056	80656	72543	42226			62769	113.3	170000	
	94.99	89324	82360	79855	78791	41696			74838	122.9	160000	
	101.76	88361	82056	80656	79597	42226			73911	113.3	170000	
	118.97	89324	82360	79855	78791	41696			78541	103.0	160000	
	142.80	88361	82056	80656	78176	42226			78299	85.5	170000	
	166.94	89324	82360	79855	78791	41696			79061	73.9	160000	
	174.00	82807	75822	72518	65903	40928			67910	60.9	150000	
204.89	82807	75822	72518	65903	40928			69459	52.9	150000		
EX..4	248.17	88361	82056	80656	79597	42226			81500	52.3	170000	
	292.49	88361	82056	80656	79597				81000	44.1	170000	
	341.95	89324	82360	79855					81000	37.7	160000	
	367.67	88361	82056	80656					81000	35.1	170000	
	403.69	89324	82360	79855					81000	32.0	160000	
	433.32	88361	82056	80656					81000	29.8	170000	
	505.63	89324	82360	79855					81000	25.5	160000	
	542.74	88361	82056	80656					82000	24.1	170000	
	609.36	88361	82056	80656					82000	21.4	170000	
	634.51	89324	82360	79855					82000	20.6	160000	
	737.62	89324	82360	79855					83000	17.9	160000	
	763.23	88361	82056	80656					84000	17.5	170000	
	892.28	89324	82360	79855					85000	15.2	160000	
	928.00	82807	75822	72518					82000	14.1	150000	
	1070.99	88361	82056	80656					86000	12.8	170000	
	1252.08	89324	82360	79855					88000	11.2	160000	
1305.00	82807	82056	72518					82500	10.1	150000		
1536.64	82807	75822	72518					83000	8.6	150000		

**B**

\* Contattare nostro ufficio tecnico commerciale / \* Please, contact our technical sales dept. / \* Bitte setzen Sie sich mit unserer technischen Abteilung in Verbindung

P <sub>tN</sub>	PS PSB	S-SB-SU FS-FSB
<b>8501</b>	159.9	80.1
<b>8502</b>	80.1	50.2
<b>8503</b>	59.8	39.9
<b>8504</b>	47.2	32.2

